

10 anos
luz



J.NORBERTO REPR. COM. LTDA

ILUMINAÇÃO

Av. Pedro Zapelini, 1119 - Centro

Fone/Fax (48) 3622-5568 - (48) 99986-2613

E-mail: jnorberto@jnorberto.com.br - www.jnorberto.com.br

88701-480 - Tubarão - Santa Catarina

STELLA

IDEIAS LUMINOSAS

CATÁLOGO 2019



A Stella nasceu da vontade de fazer a diferença, de expandir horizontes.

Nasceu da inquietação com os padrões existentes.

Temos paixão pela luz, pelo design, pelos detalhes.

Ao longo da última década, desenvolvemos uma marca sólida e singular.

Transformamos ideias em produtos, problemas em soluções.

Nossas criações exclusivas já nos levaram a ultrapassar a marca de

100 patentes requeridas - e isso é apenas o começo.

Ainda temos muito a fazer: novos produtos, novas linhas, uma nova sede.

Que venham os próximos 10 anos!

Equipe Stella

STELLA
IDEIAS LUMINOSAS

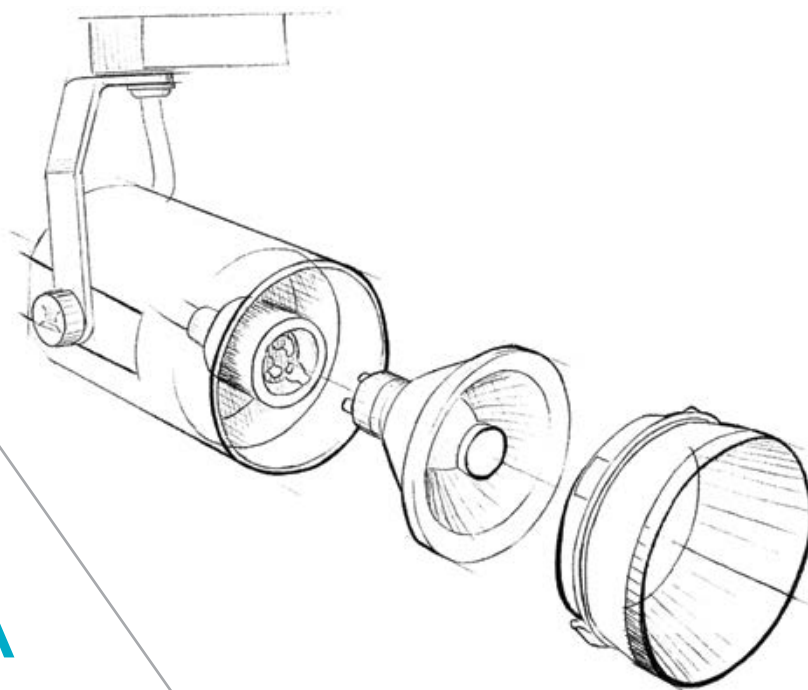

Spot Flow.

A STELLA

Para que um produto tenha a marca Stella, sua qualidade precisa ser evidente e indiscutível. Isso pode ser observado em todas as linhas de nosso completo portfólio, formado por Lâmpadas, Luminárias, Jardim, Fitas, Trilhos e Decorativa. A cada ano, criamos inúmeros novos produtos, ampliando possibilidades de uso com soluções originais e design apurado.

Em nossa Sede Central, localizada em Sapiranga (RS), são realizadas as atividades administrativas da Stella - e é lá que se encontra o nosso Centro de Desenvolvimento de Produtos. Sua estrutura contempla impressoras 3D para geração de protótipos e 18 equipamentos para testes de laboratório. O Centro de Distribuição, estrategicamente localizado em Itajaí (SC), garante que nossos produtos sejam entregues rapidamente para lojistas de todo o Brasil.

A Stella também está presente no exterior. O trabalho na nossa sede em Portugal está sendo ampliado em 2019 para possibilitar a comercialização de nossos produtos em todo o continente europeu. Temos, ainda, uma equipe que acompanha e inspeciona os processos de fabricação realizados na China.



Goniofotômetro.



Impressora 3D.

STELLA

A product with Stella brand has evident and indisputable quality. That is visible in all lines of our complete portfolio, consisting of Bulbs, Lighting Fixtures, Outdoor Lights, Light Strips, Track Lights and Decorative. Every year we create countless new products, expanding possibilities of use with original solutions and accurate design.

At our headquarters, located in Sapiranga (RS), we carry out all of Stella's administrative activities - and that is also where our Product Development Center is located. Its structure includes 3D printers for prototypes and 18 laboratory test equipment. Our Distribution Center, strategically located in Itajaí (SC), ensures that we can quickly deliver all of our products to retailers throughout Brazil.

Stella is also present abroad. The work at our headquarters in Portugal is being expanded in 2019 to enable the commercialization of all our products throughout the European continent. We also have a team that monitors and inspects the manufacturing process in China.



Lançamento: Spot Flow.

CENTRO DE DESENVOLVIMENTO DE PRODUTOS

Todo o desenvolvimento criativo da Stella é realizado no Brasil, fato que muito nos orgulha. Com uma metodologia multidisciplinar, que combina conhecimentos e experiências de diversas áreas, questionamos conceitos, inovamos. O processo de materializar uma ideia já resultou em diversos produtos autorais e mais de 100 patentes requeridas.

A atenção ao design, à durabilidade e às características luminotécnicas dos produtos é uma premissa da Stella que orienta nossos projetos do início ao fim. Nossa busca pela qualidade e confiabilidade fez necessário um rigoroso sistema interno e externo de controle de qualidade. Geramos relatórios completos sobre cada produto em nosso próprio laboratório, um dos mais avançados do Brasil, e vamos além do que as certificações exigem.



Lançamento: Embutido Narrow.



Lançamento: Arandela/Balizador Line.

PRODUCT DEVELOPMENT CENTER

All of Stella's creative development is carried out in Brazil, which is something we are very proud of. With a multidisciplinary methodology, which combines knowledge and experiences from different fields, we question concepts and innovate. The process of materializing an idea has already resulted in several copyrighted products and more than 100 patents.

The attention to design, durability and lighting characteristics of our products is a premise that guides our projects from the beginning to the end. Our pursuit on quality and reliability required a strict internal and external quality control system. We make complete reports about every product in our own laboratory, which is one of the most advanced in Brazil, and we go beyond of what any certification requires.



Produtos Stella: Lâmpadas da Linha Filamento Vintage Espiral | Escritórios: Samia Raquel Arquitetura e AC Arquitetura
Arquitetas: Samia Raquel, Andrea Miranda e Camila Fialho | CASACOR PB 2018 | Foto: Andre Mello

LÂMPADAS

- | | |
|------------------------|--------------------------|
| 06 DICROICA EVO | 18 FILAMENTO ESPIRAL |
| 07 AR EVO | 20 FILAMENTO |
| 08 PAR EVO | 23 FILAMENTO COLOR |
| 09 DICROICA | DICROICA RGBW |
| 11 PAR | 24 FILAMENTO 2700K |
| 13 AR | 26 VELA |
| 14 BI-PINO | 27 BULBO |
| 15 R7s | 29 TUBULAR T5 E T8 |
| 16 FILAMENTO MILKY | 30 ALTO FLUXO |
| 17 FILAMENTO DEFLETORA | ACESSÓRIOS PARA LÂMPADAS |

Os gráficos luminotécnicos de todos os produtos estão disponíveis no capítulo Gráficos deste catálogo e no site stella.com.br, onde também consta o tempo de garantia de cada produto.



PRO

UMA LINHA DE LÂMPADAS ÚNICAS

Design que proporciona fechos de luz nítidos e marcantes

Performance e precisão rigorosas

Tecnologia do mais alto nível

Efeitos de luz que valorizam os detalhes

IRC elevado

Modelos com tecnologia bivolt dimerizável (BDT)

Compatíveis com os melhores dimers e sistemas de automação



4W

230 lumens

MINI DICROICA EVO

DIMERIZÁVEL BDT

STH7530/27 - BIVOLT | 2700K | 230lm

PRODUTO PRO

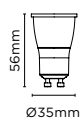

Base / Formato	GU10 / MR11
Tensão	100-240V
Eficiência luminosa	57lm/W
Intensidade luminosa	550cd
Ângulo de abertura	30°
IRC	>90
Dimerização	20-100%
Vida útil (L70)	25.000h

7W

450 lumens

DICROICA EVO

DIMERIZÁVEL BDT

STH7535/27 - BIVOLT | 2700K | 450lm

PRODUTO PRO

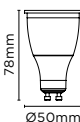

Base / Formato	GU10 / MR16
Tensão	100-240V
Eficiência luminosa	64lm/W
Intensidade luminosa	1100cd
Ângulo de abertura	36°
IRC	>90
Dimerização	20-100%
Vida útil (L70)	25.000h

4,8W

 300
lumens

 PRODUTO
PRO

AR70 EVO 12°

DIMERIZÁVEL BDT

STH6435/27 - BIVOLT

2700K

300lm

Base	GU10
Tensão	100-240V
Eficiência luminosa	62lm/W
Intensidade luminosa	3300cd
Ângulo de abertura	12°
IRC	>80
Dimerização	20-100%
Vida útil (L70)	25.000h

Incluso soquete.

4,8W

 300
lumens

 PRODUTO
PRO

AR70 EVO 24°

DIMERIZÁVEL BDT

STH6436/27 - BIVOLT

2700K

300lm

Base	GU10
Tensão	100-240V
Eficiência luminosa	62lm/W
Intensidade luminosa	1100cd
Ângulo de abertura	24°
IRC	>80
Dimerização	20-100%
Vida útil (L70)	25.000h

Incluso soquete.

12W

 720
lumens

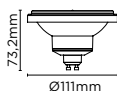
 PRODUTO
PRO

AR111 EVO 12°

DIMERIZÁVEL BDT

STH6445/27 - BIVOLT

2700K

720lm

Base	GU10
Tensão	100-240V
Eficiência luminosa	60lm/W
Intensidade luminosa	6300cd
Ângulo de abertura	12°
IRC	>80
Dimerização	20-100%
Vida útil (L70)	25.000h

Incluso soquete.

12W

 720
lumens

 PRODUTO
PRO

AR111 EVO 24°

DIMERIZÁVEL BDT

STH6446/27 - BIVOLT

2700K

720lm

Base	GU10
Tensão	100-240V
Eficiência luminosa	60lm/W
Intensidade luminosa	1900cd
Ângulo de abertura	24°
IRC	>80
Dimerização	20-100%
Vida útil (L70)	25.000h

Incluso soquete.



6W

380 lumens

LANÇAMENTO

PRODUTO PRO

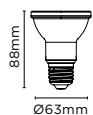

PAR20 EVO

DIMERIZÁVEL BDT



STH7080/27 - BIVOLT | 2700K | 380lm

Base	E27
Tensão	100-240V
Eficiência luminosa	63lm/W
Intensidade luminosa	1000cd
Ângulo de abertura	25°
IRC	>90
Dimerização	20-100%
Vida útil (L70)	25.000h

11W

700 lumens

LANÇAMENTO

PRODUTO PRO

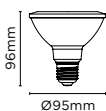

PAR30 EVO

DIMERIZÁVEL BDT



STH7085/27 - BIVOLT | 2700K | 700lm

Base	E27
Tensão	100-240V
Eficiência luminosa	63lm/W
Intensidade luminosa	2700cd
Ângulo de abertura	25°
IRC	>90
Dimerização	20-100%
Vida útil (L70)	25.000h



Produtos Stella, Bulbo Dimenzável BDT e Embutido Square com AIR70 24" | Arquiteto: Illo Silva | Mostra Glass Home 2018 | Foto: PPOUS Imagens

DICROICA PAR AR

3W
MINI DICROICA

 240
lumens

STH8513/27 - BIVOLT	2700K	240lm
STH8513/30 - BIVOLT	3000K	250lm
STH8513/40 - BIVOLT	4000K LANÇAMENTO	260lm
STH8513/65 - BIVOLT	6500K	260lm

Base / Formato	GU10 / MR11
Tensão	100-240V
Eficiência luminosa	80lm/W a 86lm/W
Intensidade luminosa 2700K	470cd
Intensidade luminosa 3000K	490cd
Intensidade luminosa 4000K e 6500K	510cd
Ângulo de abertura	36°
IRC	>80
Vida útil (L70)	25.000h

4W
MINI DICROICA

DIMERIZÁVEL BDT

 210
lumens

STH6515/27 - BIVOLT	2700K	210lm
---------------------	-------	-------

Base / Formato	GU10 / MR11
Tensão	100-240V
Eficiência luminosa	52lm/W
Intensidade luminosa	350cd
Ângulo de abertura	36°
IRC	>80
Dimerização	20-100%
Vida útil (L70)	25.000h

3W
DICROICA

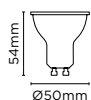
 250
lumens

STH8533/27 - BIVOLT	2700K LANÇAMENTO	250lm
STH8533/30 - BIVOLT	3000K	250lm
STH8533/65 - BIVOLT	6500K	260lm

Base / Formato	GU10 / MR16
Tensão	100-240V
Eficiência luminosa	83lm/W a 86lm/W
Intensidade luminosa	500cd
Ângulo de abertura	36°
IRC	>80
Vida útil (L70)	25.000h

**4W**

350 lumens

DICROICA

STH8534/27 - BIVOLT	2700K	350lm
STH8534/30 - BIVOLT	3000K	350lm
STH8534/40 - BIVOLT	4000K LANÇAMENTO	370lm
STH8534/65 - BIVOLT	6500K	380lm

Base / Formato	GU10 / MR16
Tensão	100-240V
Eficiência luminosa	87lm/W a 95lm/W
Intensidade luminosa 2700K e 3000K	750cd
Intensidade luminosa 4000K e 6500K	800cd
Ângulo de abertura	36°
IRC	>80
Vida útil (L70)	25.000h

4W

350 lumens

LANÇAMENTO

DICROICA 60°

STH8537/30 - BIVOLT	3000K	350lm
----------------------------	-------	-------

Base / Formato	GU10 / MR16
Tensão	100-240V
Eficiência luminosa	87lm/W
Intensidade luminosa	350cd
Ângulo de abertura	60°
IRC	>80
Vida útil (L70)	25.000h

6W

450 lumens

DICROICA

STH8535/27 - BIVOLT	2700K	450lm
STH8535/30 - BIVOLT	3000K	450lm
STH8535/40 - BIVOLT	4000K LANÇAMENTO	500lm
STH8535/65 - BIVOLT	6500K LANÇAMENTO	500lm

Base / Formato	GU10 / MR16
Tensão	100-240V
Eficiência luminosa	75lm/W a 83lm/W
Intensidade luminosa 2700K e 3000K	900cd
Intensidade luminosa 4000K e 6500K	1000cd
Ângulo de abertura	36°
IRC	>80
Vida útil (L70)	25.000h

6W

450 lumens

LANÇAMENTO

DICROICA 60°

STH8538/30 - BIVOLT	3000K	450lm
----------------------------	-------	-------

Base / Formato	GU10 / MR16
Tensão	100-240V
Eficiência luminosa	75lm/W
Intensidade luminosa	430cd
Ângulo de abertura	60°
IRC	>80
Vida útil (L70)	25.000h

6W

 460
lumens

DICROICA

DIMERIZÁVEL



STH8541/27 - 127V	2700K	460lm
STH8542/27 - 220V	2700K	460lm

Base / Formato	GU10 / MR16
Tensão	127V ou 220V
Eficiência luminosa	76lm/W
Intensidade luminosa	880cd
Ângulo de abertura	36°
IRC	>80
Dimerização	20-100%
Vida útil (L70)	25.000h

7W

 350
lumens

DICROICA 15°

DIMERIZÁVEL BDT



STH8528/27 - BIVOLT	2700K	350lm
----------------------------	-------	-------

Base / Formato	GU10 / MR16
Tensão	100-240V
Eficiência luminosa	50lm/W
Intensidade luminosa	4500cd
Ângulo de abertura	15°
IRC	>80
Dimerização	20-100%
Vida útil (L70)	25.000h

7W

 525
lumens

DICROICA

STH8526/27 - BIVOLT	2700K	525lm
STH8526/30 - BIVOLT	3000K	525lm

Base / Formato	GU10 / MR16
Tensão	100-240V
Eficiência luminosa	75lm/W
Intensidade luminosa 2700K	930cd
Intensidade luminosa 3000K	1000cd
Ângulo de abertura	36°
IRC	>80
Vida útil (L70)	25.000h

6W

 450
lumens

PAR20

DIMERIZÁVEL BDT

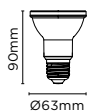

STH8060/27 - BIVOLT	2700K	450lm
----------------------------	-------	-------

Base	E27
Tensão	100-240V
Eficiência luminosa	75lm/W
Intensidade luminosa	900cd
Ângulo de abertura	36°
IRC	>80
Dimerização	20-100%
Vida útil (L70)	25.000h

**6W****PAR20**

525 lumens

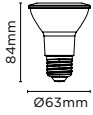

STH8020/27 - BIVOLT	2700K	525lm
STH8020/30 - BIVOLT	3000K	540lm
STH8020/40 - BIVOLT	4000K LANÇAMENTO	580lm
STH8020/65 - BIVOLT	6500K	580lm

Base	E27	
Tensão	100-240V	
Eficiência luminosa	87lm/W a 96lm/W	
Intensidade luminosa 2700K	1450cd	
Intensidade luminosa 3000K	1500cd	
Intensidade luminosa 4000K e 6500K	1650cd	
Ângulo de abertura	25°	
IRC	>80	
Vida útil (L70)	25.000h	

6W**PAR20 40°**

540 lumens

LANÇAMENTO

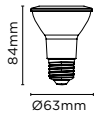

STH8024/30 - BIVOLT	3000K	540lm
STH8024/40 - BIVOLT	4000K	580lm

Base	E27	
Tensão	100-240V	
Eficiência luminosa	90lm/W e 96lm/W	
Intensidade luminosa 3000K	890cd	
Intensidade luminosa 4000K	950cd	
Ângulo de abertura	40°	
IRC	>80	
Vida útil (L70)	25.000h	

9,5W**PAR30**

900 lumens



STH8030/27 - BIVOLT	2700K LANÇAMENTO	900lm
STH8030/30 - BIVOLT	3000K	950lm
STH8030/40 - BIVOLT	4000K LANÇAMENTO	950lm
STH8030/65 - BIVOLT	6500K	950lm

Base	E27	
Tensão	100-240V	
Eficiência luminosa	94lm/W a 100lm/W	
Intensidade luminosa 2700K	2500cd	
Intensidade luminosa 3000K	2600cd	
Intensidade luminosa 4000K e 6500K	2800cd	
Ângulo de abertura	25°	
IRC	>80	
Vida útil (L70)	25.000h	

14W**PAR38**

1300 lumens

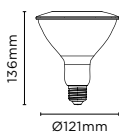

STH8035/30 - BIVOLT	3000K	1300lm
----------------------------	-------	--------

Base	E27	
Tensão	100-240V	
Eficiência luminosa	92lm/W	
Intensidade luminosa	3100cd	
Ângulo de abertura	25°	
IRC	>80	
Vida útil (L70)	25.000h	

4,8W
AR70 12°

 300
lumens

LANÇAMENTO

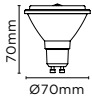
STH8433/27 - BIVOLT | 2700K | 300lm

Base	GU10
Tensão	100-240V
Eficiência luminosa	63lm/W
Intensidade luminosa	2050cd
Ângulo de abertura	12°
IRC	>80
Vida útil (L70)	25.000h

4,8W
AR70 24°

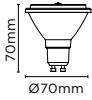
 300
lumens

STH8434/27 - BIVOLT | 2700K | 300lm

Base	GU10
Tensão	100-240V
Eficiência luminosa	63lm/W
Intensidade luminosa	950cd
Ângulo de abertura	24°
IRC	>80
Vida útil (L70)	25.000h

12W
AR111 12°

 950
lumens

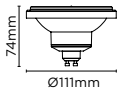
LANÇAMENTO

STH8443/27 - BIVOLT | 2700K | 950lm

Base	GU10
Tensão	100-240V
Eficiência luminosa	79lm/W
Intensidade luminosa	4250cd
Ângulo de abertura	12°
IRC	>80
Vida útil (L70)	25.000h

12W
AR111 24°

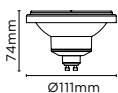
 950
lumens

STH8444/27 - BIVOLT | 2700K | 950lm

Base	GU10
Tensão	100-240V
Eficiência luminosa	79lm/W
Intensidade luminosa	1850cd
Ângulo de abertura	24°
IRC	>80
Vida útil (L70)	25.000h



BI-PINO R7s

Distribuição uniforme de luz

Alto fluxo luminoso em medidas reduzidas

Corpo e lente unificados



Produto Stella - Pendente Circe Dourado e lâmpada Bi-pino G9

2,5W

150 lumens

BI-PINO G9

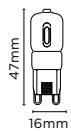

STH7121/24 - 127V	2400K	150lm
STH7122/24 - 220V	2400K	150lm
STH7121/27 - 127V	2700K	150lm
STH7122/27 - 220V	2700K	150lm
STH7121/30 - 127V	3000K LANÇAMENTO	180lm
STH7122/30 - 220V	3000K LANÇAMENTO	180lm

Base	G9
Tensão	127V ou 220V
Eficiência luminosa	60lm/W a 72lm/W
Ângulo de abertura 2400K	280°
Ângulo de abertura 2700K e 3000K	300°
IRC	>80
Vida útil (L70)	15.000h

3,5W

250 lumens

BI-PINO G9

DIMERIZÁVEL

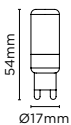

STH8151/24 - 127V	2400K	250lm
STH8152/24 - 220V	2400K	250lm

Base	G9
Tensão	127V ou 220V
Eficiência luminosa	71lm/W
Ângulo de abertura	270°
IRC	>80
Dimerização	20-100%
Vida útil (L70)	15.000h

4W

325 lumens

LANÇAMENTO

BI-PINO G9

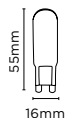

STH8141/30 - 127V	3000K	325lm
STH8142/30 - 220V	3000K	325lm

Base	G9
Tensão	127V ou 220V
Eficiência luminosa	81lm/W
Ângulo de abertura	300°
IRC	>80
Vida útil (L70)	15.000h

2W

BI-PINO G4

150
lumens

STH6103/27 - 12Vcc

2700K

150lm

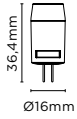

Base	G4
Tensão	12Vcc
Eficiência luminosa	75lm/W
Ângulo de abertura	250°
IRC	>80
Vida útil (L70)	15.000h

5W

R7s PALITO CURTA

500
lumens

STH5120/27 - BIVOLT

2700K

500lm

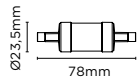

Base	R7s
Tensão	100-240V
Eficiência luminosa	100lm/W
Ângulo de abertura	360°
IRC	>80
Vida útil (L70)	25.000h

8W

R7s PALITO MÉDIA

780
lumens

STH5130/27 - BIVOLT

2700K

780lm

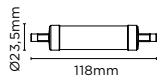

Base	R7s
Tensão	100-240V
Eficiência luminosa	98lm/W
Ângulo de abertura	360°
IRC	>80
Vida útil (L70)	25.000h

9W

R7s PALITO MÉDIA

1055
lumens

STH6140/27 - BIVOLT

2700K

1055lm

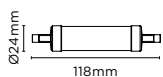

Base	R7s
Tensão	100-240V
Eficiência luminosa	117lm/W
Ângulo de abertura	360°
IRC	>80
Vida útil (L70)	15.000h



MILKY

Luz uniforme

Design atemporal e delicado

Vidro leitoso que não deixa sombras no fecho de luz

Versátil e prática

Produtos Stella. Pendente Blunt. Cobre Escovado e lâmpada G95 Balloon Filamento Milky

2W
200 lumens

MINI BULBO FILAMENTO MILKY

STH8220/27 - BIVOLT	2700K	200lm
---------------------	-------	-------

Base	E27
Tensão	100-240V
Eficiência luminosa	100lm/W
Ângulo de abertura	300°
IRC	>80
Vida útil (L70)	15.000h

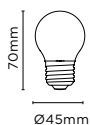

4W
400 lumens

G95 BALLOON FILAMENTO MILKY

STH8226/27 - BIVOLT	2700K	400lm
---------------------	-------	-------

Base	E27
Tensão	100-240V
Eficiência luminosa	100lm/W
Ângulo de abertura	300°
IRC	>80
Vida útil (L70)	15.000h

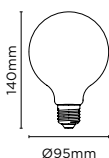

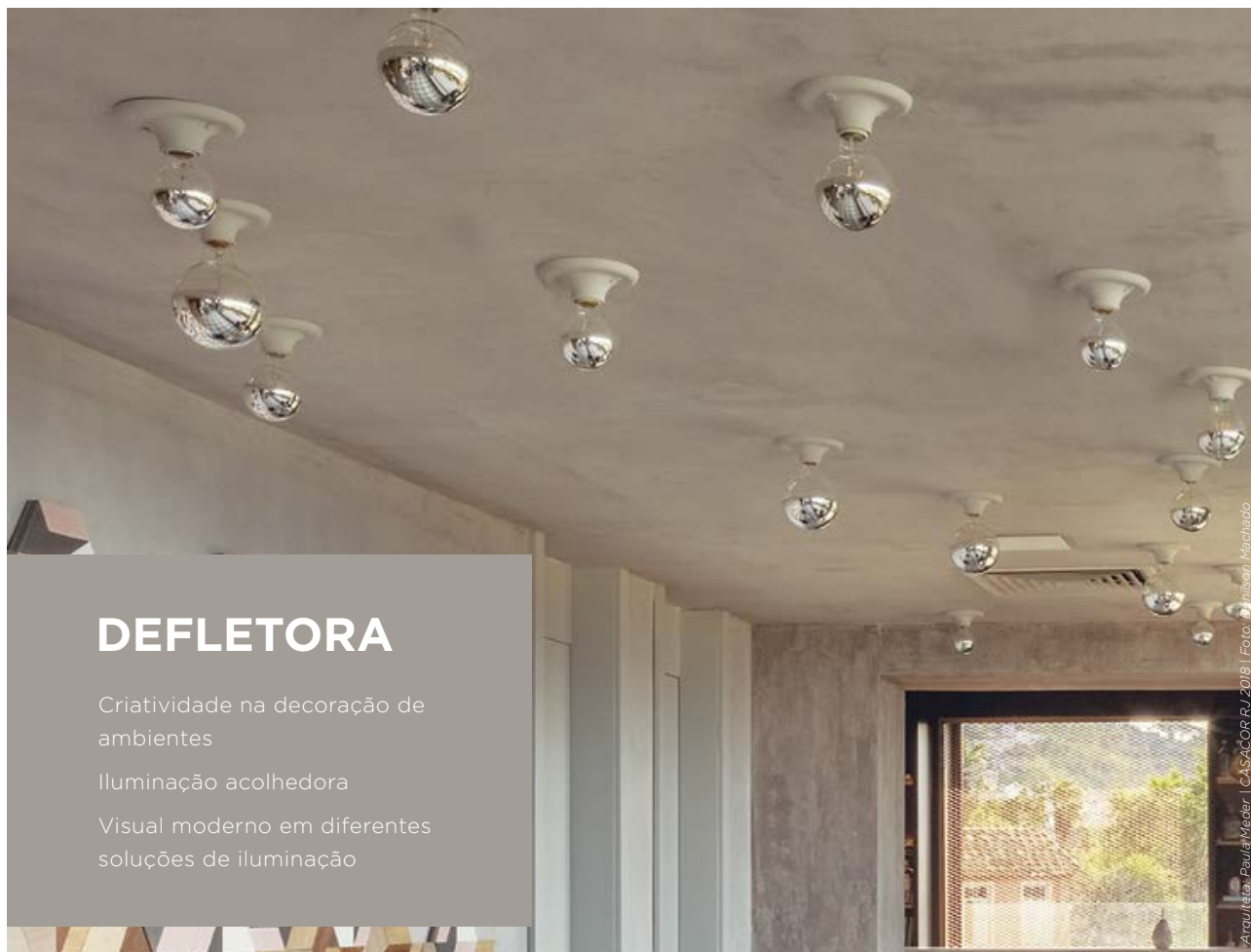

DEFLETORA

Criatividade na decoração de ambientes

Iluminação acolhedora

Visual moderno em diferentes soluções de iluminação

Arquiteta Paula Meier | CASACOR RJ 2018 | Foto: Nelson Machado

5W

400 lumens

G95 BALLOON FILAMENTO DEFLETORA

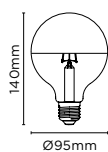

STH8285/24 - BIVOLT | 2400K | 400lm

Base	E27
Tensão	100-240V
Eficiência luminosa	80lm/W
Ângulo de abertura	190°
IRC	>80
Vida útil (L70)	15.000h

7W

600 lumens

G125 BALLOON FILAMENTO DEFLETORA

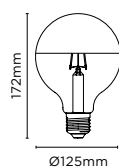

STH8290/24 - BIVOLT | 2400K | 600lm

Base	E27
Tensão	100-240V
Eficiência luminosa	86lm/W
Ângulo de abertura	190°
IRC	>80
Vida útil (L70)	15.000h

FILAMENTO ESPIRAL

Distribuição abrangente de luz
Destaca a decoração do ambiente
Formatos variados



Produtos: Stela: Pendente Blun, Jato Foco e Lâmpada G2; Balloon Filamento Vintage Espiral / Arandelas: Francieli, Hagemeister e Marília Ostermayer / Mostra Glass, Home 2018 | Foto: RPDOLs Imagens

2,5W

180 lumens

VELA LISA/CHAMA FILAMENTO ESPIRAL

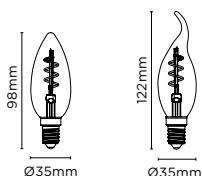

STH8383/24 - LISA - 127V	2400K	180lm
STH8384/24 - LISA - 220V	2400K	180lm
STH8393/24 - CHAMA - 127V	2400K	180lm
STH8394/24 - CHAMA - 220V	2400K	180lm

Base	E14
Tensão	127V ou 220V
Eficiência luminosa	72lm/W
Ângulo de abertura	300°
IRC	>80
Vida útil (L70)	15.000h

2,5W

180 lumens

VELA LISA/CHAMA FILAMENTO VINTAGE ESPIRAL

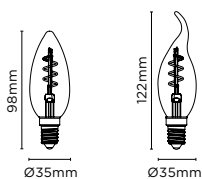

STH8381/24 - LISA - 127V	2400K	180lm
STH8382/24 - LISA - 220V	2400K	180lm
STH8391/24 - CHAMA - 127V	2400K	180lm
STH8392/24 - CHAMA - 220V	2400K	180lm

Base	E14
Tensão	127V ou 220V
Eficiência luminosa	72lm/W
Ângulo de abertura	300°
IRC	>80
Vida útil (L70)	15.000h

2,5W

200 lumens

BULBO FILAMENTO VINTAGE ESPIRAL

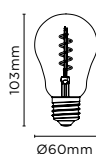

STH8240/24 - BIVOLT	2400K	200lm
---------------------	-------	-------

Base	E27
Tensão	100-240V
Eficiência luminosa	80lm/W
Ângulo de abertura	300°
IRC	>80
Vida útil (L70)	15.000h

2,5W

200 lumens

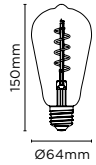

ST64 FILAMENTO VINTAGE ESPIRAL



STH8242/24 - BIVOLT | 2400K | 200lm

Base	E27
Tensão	100-240V
Eficiência luminosa	80lm/W
Ângulo de abertura	300°
IRC	>80
Vida útil (L70)	15.000h

2,5W

200 lumens

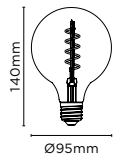

G95 BALLOON FILAMENTO VINTAGE ESPIRAL



STH8244/24 - BIVOLT | 2400K | 200lm

Base	E27
Tensão	100-240V
Eficiência luminosa	80lm/W
Ângulo de abertura	300°
IRC	>80
Vida útil (L70)	15.000h

2,5W

200 lumens

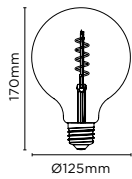

G125 BALLOON FILAMENTO VINTAGE ESPIRAL



STH8246/24 - BIVOLT | 2400K | 200lm

Base	E27
Tensão	100-240V
Eficiência luminosa	80lm/W
Ângulo de abertura	300°
IRC	>80
Vida útil (L70)	15.000h

2,5W

200 lumens

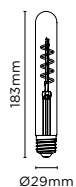

T30 FILAMENTO VINTAGE ESPIRAL



STH8247/24 - BIVOLT | 2400K | 200lm

Base	E27
Tensão	100-240V
Eficiência luminosa	80lm/W
Ângulo de abertura	300°
IRC	>80
Vida útil (L70)	15.000h

FILAMENTO

Luz suave

Opções dimerizáveis

Lâmpada como elemento decorativo

Produtos Stella - Pendente Filamento e lâmpadas ST64 Filamento Vintage e 130 Filamento Vintage

2W

200 lumens

VELA LISA/CHAMA FILAMENTO

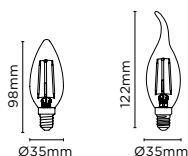

STH6301/24 - LISA - 127V	2400K	200lm
STH6302/24 - LISA - 220V	2400K	200lm
STH6311/24 - CHAMA - 127V	2400K	200lm
STH6312/24 - CHAMA - 220V	2400K	200lm

Base	E14
Tensão	127V ou 220V
Eficiência luminosa	100lm/W
Ângulo de abertura	270°
IRC	>80
Vida útil (L70)	15.000h

2W

200 lumens

VELA LISA/CHAMA FILAMENTO VINTAGE

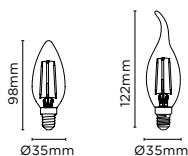

STH6321/24 - LISA - 127V	2400K	200lm
STH6322/24 - LISA - 220V	2400K	200lm
STH6331/24 - CHAMA - 127V	2400K	200lm
STH6332/24 - CHAMA - 220V	2400K	200lm

Base	E14
Tensão	127V ou 220V
Eficiência luminosa	100lm/W
Ângulo de abertura	270°
IRC	>80
Vida útil (L70)	15.000h

4W

250 lumens

VELA LISA/CHAMA FILAMENTO

DIMERIZÁVEL

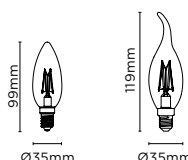

STH8361/24 - LISA - 127V	2400K	250lm
STH8362/24 - LISA - 220V LANÇAMENTO	2400K	250lm
STH8371/24 - CHAMA - 127V	2400K	250lm

Base	E14
Tensão	127V ou 220V
Eficiência luminosa	63lm/W
Ângulo de abertura	300°
IRC	>90
Dimerização	20-100%
Vida útil (L70)	15.000h

2W

 200
lumens

MINI BULBO FILAMENTO VINTAGE

STH6334/24 - BIVOLT | 2400K | 200lm

Base	E27
Tensão	100-240V
Eficiência luminosa	100lm/W
Ângulo de abertura	270°
IRC	>80
Vida útil (L70)	15.000h

2W

 200
lumens

BULBO FILAMENTO VINTAGE

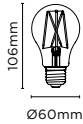
STH6335/24 - BIVOLT | 2400K | 200lm

Base	E27
Tensão	100-240V
Eficiência luminosa	100lm/W
Ângulo de abertura	360°
IRC	>80
Vida útil (L70)	15.000h

2W

 200
lumens

ST64 FILAMENTO VINTAGE

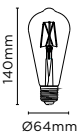
STH6338/24 - BIVOLT | 2400K | 200lm

Base	E27
Tensão	100-240V
Eficiência luminosa	100lm/W
Ângulo de abertura	360°
IRC	>80
Vida útil (L70)	15.000h

2W

 200
lumens

G95 BALLOON FILAMENTO VINTAGE

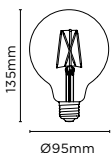
STH6336/24 - BIVOLT | 2400K | 200lm

Base	E27
Tensão	100-240V
Eficiência luminosa	100lm/W
Ângulo de abertura	360°
IRC	>80
Vida útil (L70)	15.000h



2W

200 lumens

G125 BALLOON FILAMENTO VINTAGE

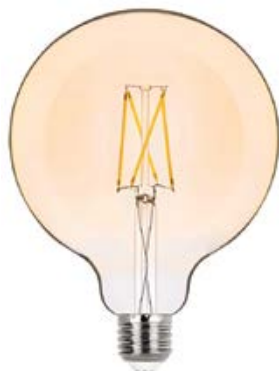
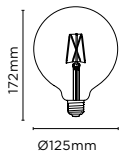

STH6337/24 - BIVOLT | 2400K | 200lm

Base	E27
Tensão	100-240V
Eficiência luminosa	100lm/W
Ângulo de abertura	360°
IRC	>80
Vida útil (L70)	15.000h

2W

200 lumens

T30 FILAMENTO VINTAGE



STH6339/24 - BIVOLT | 2400K | 200lm

Base	E27
Tensão	100-240V
Eficiência luminosa	100lm/W
Ângulo de abertura	360°
IRC	>80
Vida útil (L70)	15.000h

4,5W

350 lumens

BULBO FILAMENTO VINTAGE

DIMERIZÁVEL

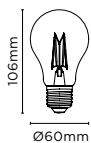

STH8261/24 - 127V | 2400K | 350lm

STH8262/24 - 220V | 2400K | 350lm

Base	E27
Tensão	127V ou 220V
Eficiência luminosa	78lm/W
Ângulo de abertura	300°
IRC	>80
Dimerização	20-100%
Vida útil (L70)	15.000h

4,5W

350 lumens

ST64 FILAMENTO VINTAGE

DIMERIZÁVEL

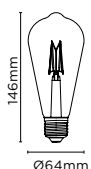

STH8271/24 - 127V | 2400K | 350lm

STH8272/24 - 220V | 2400K | 350lm

Base	E27
Tensão	127V ou 220V
Eficiência luminosa	78lm/W
Ângulo de abertura	300°
IRC	>80
Dimerização	20-100%
Vida útil (L70)	15.000h

4,5W

350
lumens

G95 BALLOON FILAMENTO VINTAGE

DIMERIZÁVEL

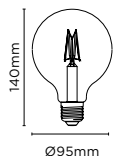

STH8281/24 - 127V	2400K	350lm
STH8282/24 - 220V	2400K	350lm

Base	E27
Tensão	127V ou 220V
Eficiência luminosa	78lm/W
Ângulo de abertura	300°
IRC	>80
Dimerização	20-100%
Vida útil (L70)	15.000h



Produto: Stella Mini Bulbo Filamento Colori | Arquitetas: Mariah Zaganel e
Eduarda Zaganel | Projeto Civil: Franchisco Zaganel | Mostre Glass Home
2018 | Foto: RPO/S Imagens

2W

MINI BULBO FILAMENTO COLOR

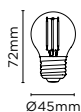

STH6340/AZ - BIVOLT	LUZ AZUL
STH6340/RS - BIVOLT	LUZ ROSA
STH6340/VD - BIVOLT	LUZ VERDE
STH6340/VM - BIVOLT	LUZ VERMELHA

Base	E27
Tensão	100-240V
Ângulo de abertura	270°
Vida útil (L70)	15.000h

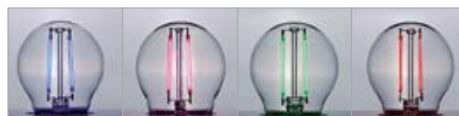

5W

200 lumens
em 3000K

DICROICA RGBW

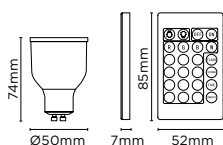

STH7590/RGBW - BIVOLT	RGB/3000K	200lm
-----------------------	-----------	-------

Base / Formato	GU10 / MR16
Tensão	100-240V
Eficiência luminosa 3000K	40lm/W
Ângulo de abertura	40°
IRC	>80 (Luz Branca)
Vida útil (L70)	15.000h

Incluso controle IR

A tecnologia RGBW corresponde às seguintes variações de cor: R (red) - vermelho, G (green) - verde, B (blue) - azul e W (white) - branco.

FILAMENTO 2700K

Tonalidade de cor quente em lâmpadas de vidro translúcido, perfeitas para substituir as halógenas.

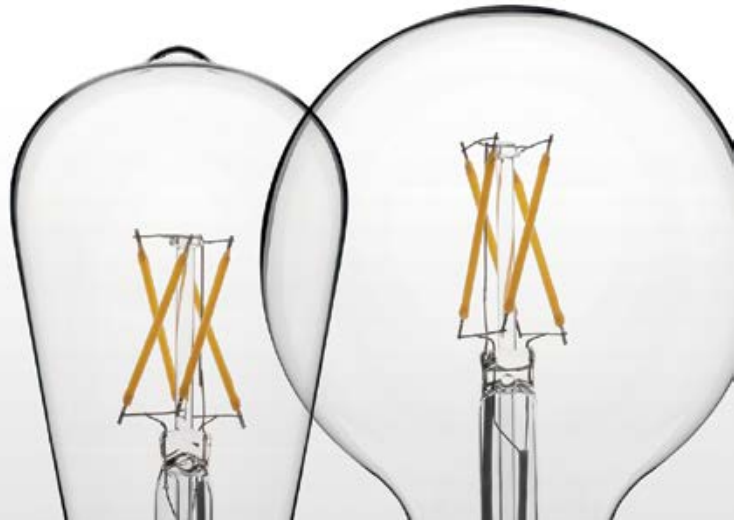

2W

200 lumens

VELA LISA/CHAMA FILAMENTO

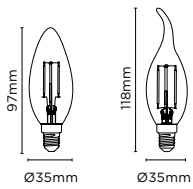

STH7301/27 - LISA - 127V	2700K	200lm
STH7302/27 - LISA - 220V	2700K	200lm
STH7311/27 - CHAMA - 127V	2700K	200lm
STH7312/27 - CHAMA - 220V	2700K	200lm

Base	E14
Tensão	127V ou 220V
Eficiência luminosa	100lm/W
Ângulo de abertura	360°
IRC	>80
Vida útil (L70)	15.000h

4W

400 lumens

BULBO FILAMENTO

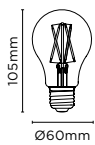

STH7210/27 - BIVOLT	2700K	400lm
---------------------	-------	-------

Base	E27
Tensão	100-240V
Eficiência luminosa	100lm/W
Ângulo de abertura	360°
IRC	>80
Vida útil (L70)	25.000h

4W

400 lumens

ST64 FILAMENTO

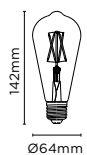

STH7212/27 - BIVOLT	2700K	400lm
---------------------	-------	-------

Base	E27
Tensão	100-240V
Eficiência luminosa	100lm/W
Ângulo de abertura	360°
IRC	>80
Vida útil (L70)	25.000h

4W

G95 BALLOON FILAMENTO

400
lumens

STH7211/27 - BIVOLT

2700K

400lm

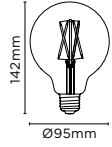

Base	E27
Tensão	100-240V
Eficiência luminosa	100lm/W
Ângulo de abertura	360°
IRC	>80
Vida útil (L70)	15.000h



Produtos Stella - Lustre Refinado e Vela Chama Filamento



VELA | BULBO ALTO FLUXO TUBULAR



3W

VELA FOSCA

260
lumens

STH7310/30 - BIVOLT | 3000K | 260lm

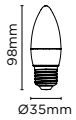

Base	E27
Tensão	100-240V
Eficiência luminosa	86lm/W
Ângulo de abertura	230°
IRC	>80
Vida útil (L70)	15.000h

3W

VELA FOSCA

250
lumens

STH6300/27 - BIVOLT | 2700K | 250lm

STH6300/30 - BIVOLT | 3000K | 260lm

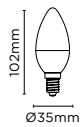

Base	E14
Tensão	100-240V
Eficiência luminosa	83lm/W e 86lm/W
Ângulo de abertura	230°
IRC	>80
Vida útil (L70)	15.000h

6W

VELA CHAMA

DIMERIZÁVEL

490
lumens

STH7351/27 - 127V | 2700K | 490lm

STH7352/27 - 220V | 2700K | 490lm

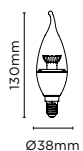

Base	E14
Tensão	127V ou 220V
Eficiência luminosa	81lm/W
Ângulo de abertura	200°
IRC	>80
Dimerização	20-100%
Vida útil (L70)	15.000h

3W
250 lumens

MINI BULBO

STH9200/27 - BIVOLT	2700K	250lm
STH9200/30 - BIVOLT	3000K	250lm

Base	E27
Tensão	100-240V
Eficiência luminosa	83lm/W
Ângulo de abertura	230°
IRC	>80
Vida útil (L70)	15.000h



9,5W
806 lumens

G95 BALLOON

STH6260/27 - BIVOLT	2700K	806lm
----------------------------	-------	-------

Base	E27
Tensão	100-240V
Eficiência luminosa	85lm/W
Ângulo de abertura	220°
IRC	>80
Vida útil (L70)	15.000h

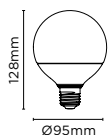

4,9W
400 lumens

BULBO

STH8263/30 - BIVOLT	3000K	400lm
STH8263/40 - BIVOLT	4000K	450lm
STH7253/65' - BIVOLT	6500K	450lm

Base	E27
Tensão	100-240V
Eficiência luminosa	81lm/W a 96lm/W
Ângulo de abertura 3000K e 4000K	170°
Ângulo de abertura 6500K	150°
IRC	>80
Vida útil (L70)	25.000h

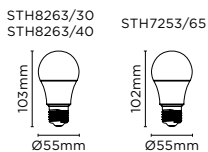

¹ Potência: 4,7W

7W
560 lumens

BULBO

STH8264/27 - BIVOLT	2700K	560lm
STH8234/30 - BIVOLT	3000K	560lm
STH8264/40 - BIVOLT	4000K	600lm
STH7264/65 - BIVOLT	6500K	560lm

Base	E27
Tensão	100-240V
Eficiência luminosa	80lm/W a 85lm/W
Ângulo de abertura 2700K e 4000K	170°
Ângulo de abertura 3000K	230°
Ângulo de abertura 6500K	220°
IRC	>80
Vida útil (L70)	25.000h

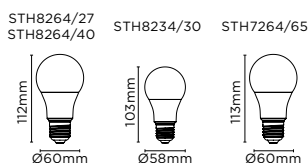

**9W****BULBO**720
lumensSTH8265/27
STH8265/30
STH8265/40

STH7265/65



STH8265/27 - BIVOLT	2700K	720lm
STH8265/30 - BIVOLT	3000K	750lm
STH8265/40 - BIVOLT	4000K	806lm
STH7265/65 - BIVOLT	6500K	810lm

Base	E27
Tensão	100-240V
Eficiência luminosa	80lm/W a 90lm/W
Ângulo de abertura 2700K, 3000K e 4000K	170°
Ângulo de abertura 6500K	220°
IRC	>80
Vida útil (L70)	25.000h

9,8W**BULBO**

DIMERIZÁVEL BDT

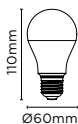
810
lumens

STH7250/27 - BIVOLT	2700K	810lm
---------------------	-------	-------

Base	E27
Tensão	100-240V
Eficiência luminosa	82lm/W
Ângulo de abertura	220°
IRC	>80
Dimerização	20-100%
Vida útil (L70)	25.000h

9,9W**BULBO**1018
lumens

STH8236/30

STH7256/65

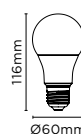

STH8236/30 - BIVOLT	3000K	1018lm
STH7256/65 - BIVOLT	6500K	1055lm

Base	E27
Tensão	100-240V
Eficiência luminosa	103lm/W e 106lm/W
Ângulo de abertura 3000K	230°
Ângulo de abertura 6500K	150°
IRC	>80
Vida útil (L70)	25.000h

¹ Potência: 10W**14W****BULBO**1600
lumens

STH7238/65 ² - BIVOLT	6500K	1600lm
----------------------------------	-------	--------

Base	E27
Tensão	100-240V
Eficiência luminosa	114lm/W
Ângulo de abertura	200°
IRC	>80
Vida útil (L70)	25.000h

² Produto disponível apenas enquanto durarem os estoques.

9W
TUBULAR T5 55cm

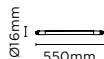
 950
lumens

STH8605/30 - BIVOLT	3000K	950lm
STH8605/65 - BIVOLT	6500K	1000lm

Base	G5
Tensão	100-240V
Eficiência luminosa	106lm/W e 111lm/W
Ângulo de abertura	150°
IRC	>80
Vida útil (L70)	25.000h

18W
TUBULAR T5 115cm

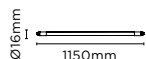
 1900
lumens

STH8615/30 - BIVOLT	3000K	1900lm
STH8615/40 - BIVOLT	4000K	2000lm
STH8615/65 - BIVOLT	6500K	2000lm

Base	G5
Tensão	100-240V
Eficiência luminosa	106lm/W e 111lm/W
Ângulo de abertura	150°
IRC	>80
Vida útil (L70)	25.000h

10W
TUBULAR T8 60cm

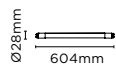
 900
lumens

STH7607/30 - BIVOLT	3000K	900lm
STH7607/40 - BIVOLT	4000K	900lm
STH7607/65 - BIVOLT	6500K	900lm

Base	G13
Tensão	100-240V
Eficiência luminosa	90lm/W
Ângulo de abertura	200°
IRC	>80
Vida útil (L70)	25.000h

20W
TUBULAR T8 120cm

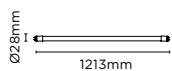
 1850
lumens

STH7617/30 - BIVOLT	3000K	1850lm
STH7617/40 - BIVOLT	4000K	1850lm
STH7617/65 - BIVOLT	6500K	1850lm

Base	G13
Tensão	100-240V
Eficiência luminosa	92lm/W
Ângulo de abertura	200°
IRC	>80
Vida útil (L70)	25.000h



16W

ALTO FLUXO

1800
lumens

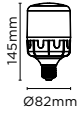

STH7292/65 - BIVOLT | 6500K | 1800lm

Base	E27
Tensão	100-240V
Eficiência luminosa	112lm/W
Ângulo de abertura	180°
IRC	>80
Vida útil (L70)	25.000h

25W

ALTO FLUXO

2700
lumens

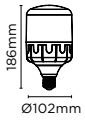

STH7293/65 - BIVOLT | 6500K | 2700lm

Base	E27
Tensão	100-240V
Eficiência luminosa	108lm/W
Ângulo de abertura	180°
IRC	>80
Vida útil (L70)	25.000h

35W

ALTO FLUXO

3600
lumens

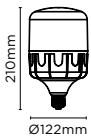

STH7294/65 - BIVOLT | 6500K | 3600lm

Base	E27
Tensão	100-240V
Eficiência luminosa	102lm/W
Ângulo de abertura	180°
IRC	>80
Vida útil (L70)	25.000h

**SOQUETES PARA
LÂMPADAS LED
BASE GU10**



STH5599

Contém 2 unidades
Potência máxima 40W

**ADAPTADORES
E27 PARA E14**



STH3499

Contém 2 unidades
Potência máxima 40W



Produtos Stella: Embutidos da Linha Square | Escritório: Klaus Menken - Arquitetura & Construção | Arquiteta: Adriana Klaus | Mostra Elite Design 2018 | Foto: RPDOIS Imagens

LUMINÁRIAS

- 32 EMBUTIDO NARROW
- 34 EMBUTIDO SQUARE
- 40 PAINEL DEEP
- 42 PAINÉIS
- 46 PERFIL LINIE
- 48 PLAFON QUADRAT
EMBUTIDO PARA MÓVEIS
- 49 LUMINÁRIA FLAT
- 50 EMBUTIDO EASY

Os gráficos luminotécnicos de todos os produtos estão disponíveis no capítulo Gráficos deste catálogo e no site stella.com.br, onde também consta o tempo de garantia de cada produto.



NARROW MRT1 - STH910BR/PTO NARROW MRT6 - STH915PPTO



NARROW

LUZ CONTROLADA

- Facho de luz estreito
- Fonte luminosa recuada
- Conforto visual
- Forma retilínea

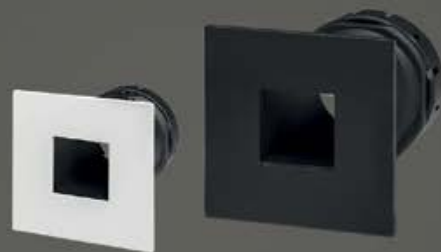

NARROW MR11

EMBUTIDO FOCO FECHADO

LANÇAMENTO

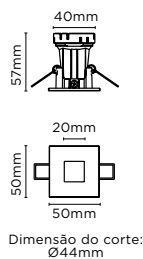

STH9910BR/PTO

BRANCO/PRETO

Tipo de lâmpada / Base	MR11 / GU10
Potência máxima	15W
Tensão	127V ou 220V
Abertura do fecho de luz	≈20°
Material predominante	Alumínio

Incluso soquete GU10. Não acompanha lâmpada. Indicamos o uso de lâmpada LED Stella.

PATENTE REQUERIDA

NARROW MR11

EMBUTIDO FOCO FECHADO

LANÇAMENTO

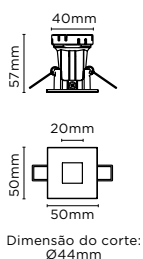

STH9910PTO

PRETO

Tipo de lâmpada / Base	MR11 / GU10
Potência máxima	15W
Tensão	127V ou 220V
Abertura do fecho de luz	≈20°
Material predominante	Alumínio

Incluso soquete GU10. Não acompanha lâmpada. Indicamos o uso de lâmpada LED Stella.

PATENTE REQUERIDA

NARROW MR16

EMBUTIDO FOCO FECHADO

LANÇAMENTO

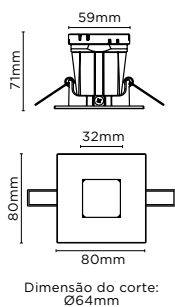

STH9915BR/PTO

BRANCO/PRETO

Tipo de lâmpada / Base	MR16 / GU10
Potência máxima	15W
Tensão	127V ou 220V
Abertura do fecho de luz	≈25°
Material predominante	Alumínio

Incluso soquete GU10. Não acompanha lâmpada. Indicamos o uso de lâmpada LED Stella.

PATENTE REQUERIDA

NARROW MR16

EMBUTIDO FOCO FECHADO

LANÇAMENTO

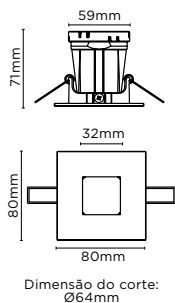

STH9915PTO

PRETO

Tipo de lâmpada / Base	MR16 / GU10
Potência máxima	15W
Tensão	127V ou 220V
Abertura do fecho de luz	≈25°
Material predominante	Alumínio

Incluso soquete GU10. Não acompanha lâmpada. Indicamos o uso de lâmpada LED Stella.

PATENTE REQUERIDA



SQUARE MR16 - STH8915PTO



SQUARE LUZ RECUADA

Borda superfina
Recuo da fonte luminosa
Fluidez no design
Melhor propagação da luz

As tabelas de efeitos e os gabaritos de corte estão disponíveis no capítulo Gráficos deste catálogo e também no site stella.com.br.

S Q U A R E
(A F O R M A D A L U Z)



SQUARE
LUZ RECUADA



SQUARE GHOST
LUZ INVISÍVEL



SQUARE ANGLE
LUZ ANGULAR

SQUARE MR11 EMBUTIDO DIRECIONÁVEL

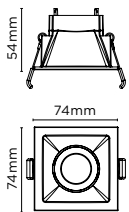

Dimensão do corte:
62x62mm



STH8910BR	BRANCO
STH8910BR/PTO	BRANCO/PRETO
STH8910PTO	PRETO LANÇAMENTO

Tipo de lâmpada / Base	MR11 / GU10
Potência máxima	15W
Tensão	127V ou 220V
Material	Alumínio

Incluso soquete GU10. Não acompanha lâmpada.
Indicamos o uso de lâmpada LED Stella.

PRODUTO PATENTEADO

SQUARE MR16 EMBUTIDO DIRECIONÁVEL

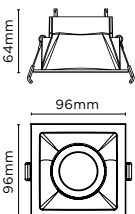

Dimensão do corte:
80x80mm



STH8915BR	BRANCO
STH8915BR/PTO	BRANCO/PRETO
STH8915PTO	PRETO LANÇAMENTO

Tipo de lâmpada / Base	MR16 / GU10
Potência máxima	15W
Tensão	127V ou 220V
Material	Alumínio

Incluso soquete GU10. Não acompanha lâmpada.
Indicamos o uso de lâmpada LED Stella.

PRODUTO PATENTEADO

SQUARE PAR20

EMBUTIDO DIRECIONÁVEL



Dimensão do corte:
100x100mm

STH8920BR	BRANCO
STH8920BR/PTO	BRANCO/PRETO
STH8920PTO	PRETO LANÇAMENTO

Tipo de lâmpada / Base	PAR20 / E27
Potência máxima	20W
Tensão	127V ou 220V
Material	Alumínio

Incluso soquete E27. Não acompanha lâmpada.
Indicamos o uso de lâmpada LED Stella.

PRODUTO PATENTEADO

SQUARE PAR30

EMBUTIDO DIRECIONÁVEL



Dimensão do corte:
127x127mm

STH8925BR	BRANCO
STH8925BR/PTO	BRANCO/PRETO
STH8925PTO	PRETO LANÇAMENTO

Tipo de lâmpada / Base	PAR30 / E27
Potência máxima	30W
Tensão	127V ou 220V
Material	Alumínio

Incluso soquete E27. Não acompanha lâmpada.
Indicamos o uso de lâmpada LED Stella.

PRODUTO PATENTEADO

SQUARE AR70

EMBUTIDO DIRECIONÁVEL



Dimensão do corte:
100x100mm

STH8930BR	BRANCO
STH8930BR/PTO	BRANCO/PRETO
STH8930PTO	PRETO LANÇAMENTO

Tipo de lâmpada / Base	AR70 / GU10
Potência máxima	20W
Tensão	127V ou 220V
Material	Alumínio

Incluso soquete GU10. Não acompanha lâmpada.
Indicamos o uso de lâmpada LED Stella.

PRODUTO PATENTEADO

SQUARE AR111

EMBUTIDO DIRECIONÁVEL



Dimensão do corte:
145x145mm

STH8935BR	BRANCO
STH8935BR/PTO	BRANCO/PRETO
STH8935PTO	PRETO LANÇAMENTO

Tipo de lâmpada / Base	AR111 / GU10
Potência máxima	20W
Tensão	127V ou 220V
Material	Alumínio

Incluso soquete GU10. Não acompanha lâmpada.
Indicamos o uso de lâmpada LED Stella.

PRODUTO PATENTEADO



SQUARE GHOST - STH8945PTO



SQUARE GHOST

LUZ INVISÍVEL

Reco superprofundo da fonte luminosa

Iluminação cênica

Conforto visual

As tabelas de efeitos e os gabaritos de corte estão disponíveis no capítulo Gráficos deste catálogo e também no site stella.com.br.

S Q U A R E
(A F O R M A D A L U Z)



S Q U A R E
L U Z R E C U A D A



S Q U A R E G H O S T
L U Z I N V I S Í V E L



S Q U A R E A N G L E
L U Z A N G U L A R

SQUARE GHOST MR11

EMBUTIDO DIRECIONÁVEL

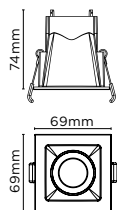

Dimensão do corte:
60x60mm



STH8940BR	BRANCO
STH8940BR/PTO	BRANCO/PRETO
STH8940PTO	PRETO LANÇAMENTO

Tipo de lâmpada / Base	MR11 / GU10
Potência máxima	15W
Tensão	127V ou 220V
Material	Alumínio

Incluso soquete GU10. Não acompanha lâmpada. Indicamos o uso de lâmpada LED Stella.

PRODUTO PATENTEADO

SQUARE GHOST MR16

EMBUTIDO DIRECIONÁVEL

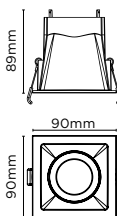

Dimensão do corte:
79x79mm



STH8945BR	BRANCO
STH8945BR/PTO	BRANCO/PRETO
STH8945PTO	PRETO LANÇAMENTO

Tipo de lâmpada / Base	MR16 / GU10
Potência máxima	15W
Tensão	127V ou 220V
Material	Alumínio

Incluso soquete GU10. Não acompanha lâmpada. Indicamos o uso de lâmpada LED Stella.

PRODUTO PATENTEADO

SQUARE GHOST PAR20

EMBUTIDO DIRECIONÁVEL

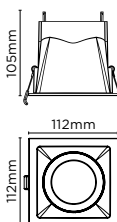

Dimensão do corte:
99x99mm



STH8950BR	BRANCO
STH8950BR/PTO	BRANCO/PRETO
STH8950PTO	PRETO LANÇAMENTO

Tipo de lâmpada / Base	PAR20 / E27
Potência máxima	20W
Tensão	127V ou 220V
Material	Alumínio

Incluso soquete E27. Não acompanha lâmpada. Indicamos o uso de lâmpada LED Stella.

PRODUTO PATENTEADO

SQUARE GHOST AR70

EMBUTIDO DIRECIONÁVEL

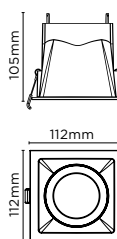

Dimensão do corte:
99x99mm



STH8955BR	BRANCO
STH8955BR/PTO	BRANCO/PRETO
STH8955PTO	PRETO LANÇAMENTO

Tipo de lâmpada / Base	AR70 / GU10
Potência máxima	20W
Tensão	127V ou 220V
Material	Alumínio

Incluso soquete GU10. Não acompanha lâmpada. Indicamos o uso de lâmpada LED Stella.

PRODUTO PATENTEADO



SQUARE ANGLE - STH8975PTO



SQUARE ANGLE

LUZ ANGULAR

Maior alcance do fecho de luz

Iluminação direcionada
sem obstáculos

As tabelas de efeitos e os gabaritos de corte
estão disponíveis no capítulo Gráficos deste
catálogo e também no site stella.com.br.

S Q U A R E
(A F O R M A D A L U Z)



S Q U A R E
LUZ RECUADA



S Q U A R E G H O S T
LUZ INVISÍVEL



S Q U A R E A N G L E
LUZ ANGULAR

SQUARE ANGLE MR11 25°

EMBUTIDO ANGULAR

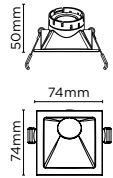

Dimensão do corte:
60x60mm



STH8960BR	BRANCO
STH8960BR/PTO	BRANCO/PRETO
STH8960PTO	PRETO LANÇAMENTO

Tipo de lâmpada / Base	MR11 / GU10
Potência máxima	15W
Tensão	127V ou 220V
Ângulo do embutido	25°
Material predominante	Alumínio

Incluso soquete GU10. Não acompanha lâmpada. Indicamos o uso de lâmpada LED Stella.

PRODUTO PATENTEADO

SQUARE ANGLE MR11 40°

EMBUTIDO ANGULAR

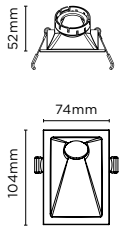

Dimensão do corte:
60x90mm



STH8965BR	BRANCO
STH8965BR/PTO	BRANCO/PRETO
STH8965PTO	PRETO LANÇAMENTO

Tipo de lâmpada / Base	MR11 / GU10
Potência máxima	15W
Tensão	127V ou 220V
Ângulo do embutido	40°
Material predominante	Alumínio

Incluso soquete GU10. Não acompanha lâmpada. Indicamos o uso de lâmpada LED Stella.

PRODUTO PATENTEADO

SQUARE ANGLE MR16 25°

EMBUTIDO ANGULAR

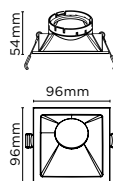

Dimensão do corte:
80x80mm



STH8970BR	BRANCO
STH8970BR/PTO	BRANCO/PRETO
STH8970PTO	PRETO LANÇAMENTO

Tipo de lâmpada / Base	MR16 / GU10
Potência máxima	15W
Tensão	127V ou 220V
Ângulo do embutido	25°
Material predominante	Alumínio

Incluso soquete GU10. Não acompanha lâmpada. Indicamos o uso de lâmpada LED Stella.

PRODUTO PATENTEADO

SQUARE ANGLE MR16 40°

EMBUTIDO ANGULAR

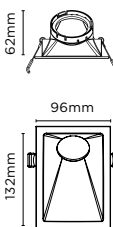

Dimensão do corte:
80x116mm



STH8975BR	BRANCO
STH8975BR/PTO	BRANCO/PRETO
STH8975PTO	PRETO LANÇAMENTO

Tipo de lâmpada / Base	MR16 / GU10
Potência máxima	15W
Tensão	127V ou 220V
Ângulo do embutido	40°
Material predominante	Alumínio

Incluso soquete GU10. Não acompanha lâmpada. Indicamos o uso de lâmpada LED Stella.

PRODUTO PATENTEADO



PAINEL DEEP

FONTE DE LUZ RECUADA

- Novo conceito em painéis LED
- Borda superfina
- Reco da fonte de luz
- Praticidade com fonte integrada



12W

750 lumens

LANÇAMENTO

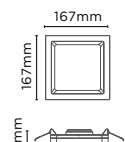

Dimensão do corte:
155x155mm

PAINEL DEEP
FONTE DE LUZ RECUADA



STH8902/30 - BIVOLT	3000K	750lm
STH8902/40 - BIVOLT	4000K	800lm
STH8902/57 - BIVOLT	5700K	850lm

Tensão	100-240V
Eficiência luminosa	63lm/W a 71lm/W
Ângulo de abertura	120°
IRC	>70
Vida útil (L70)	25.000h
Material predominante	Polycarbonato

Inclusas presilhas para fixação.
Fonte integrada.
PATENTE REQUERIDA

18W

1300 lumens

LANÇAMENTO

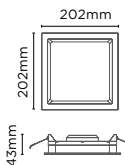

Dimensão do corte:
185x185mm

PAINEL DEEP
FONTE DE LUZ RECUADA



STH8903/30 - BIVOLT	3000K	1300lm
STH8903/40 - BIVOLT	4000K	1400lm
STH8903/57 - BIVOLT	5700K	1500lm

Tensão	100-240V
Eficiência luminosa	72lm/W a 83lm/W
Ângulo de abertura	120°
IRC	>70
Vida útil (L70)	25.000h
Material predominante	Polycarbonato

Inclusas presilhas para fixação.
Fonte integrada.
PATENTE REQUERIDA

24W

1600 lumens

LANÇAMENTO

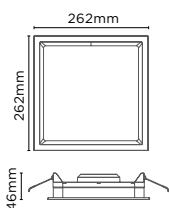

Dimensão do corte:
248x248mm

PAINEL DEEP
FONTE DE LUZ RECUADA



STH8904/30 - BIVOLT	3000K	1600lm
STH8904/40 - BIVOLT	4000K	1700lm
STH8904/57 - BIVOLT	5700K	1800lm

Tensão	100-240V
Eficiência luminosa	67lm/W a 75lm/W
Ângulo de abertura	120°
IRC	>70
Vida útil (L70)	25.000h
Material predominante	Polycarbonato

Inclusas presilhas para fixação.
Fonte integrada.
PATENTE REQUERIDA

30W

2100 lumens

LANÇAMENTO

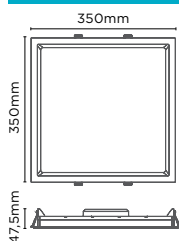

Dimensão do corte:
330,5x330,5mm

PAINEL DEEP
FONTE DE LUZ RECUADA



STH8905/30 - BIVOLT	3000K	2100lm
STH8905/40 - BIVOLT	4000K	2200lm
STH8905/57 - BIVOLT	5700K	2300lm

Tensão	100-240V
Eficiência luminosa	70lm/W a 77lm/W
Ângulo de abertura	120°
IRC	>70
Vida útil (L70)	25.000h
Material predominante	Polycarbonato

Inclusas presilhas para fixação.
Fonte integrada.
PATENTE REQUERIDA



PAINÉIS

Variedade de tamanhos e potências

Opções em tonalidades quentes, neutras e frias

Alta eficiência energética

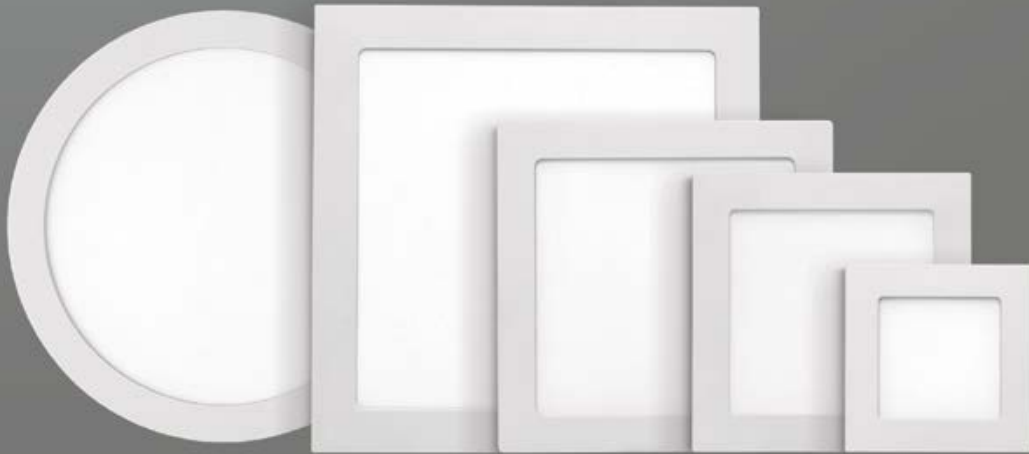

6W
350 lumens
LANÇAMENTO

PAINEL

12,8x12,8cm

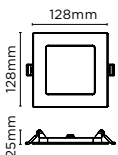

Dimensão do corte:
115x115mm



STH9951Q/30 - BIVOLT	3000K	350lm
STH9951Q/40 - BIVOLT	4000K	380lm
STH9951Q/65 - BIVOLT	6500K	400lm

Tensão	100-240V
Eficiência luminosa	58lm/W a 67lm/W
Ângulo de abertura	120°
IRC	>70
Vida útil (L70)	25.000h
Material predominante	Polycarbonato

Inclusas presilhas para fixação.
Fonte integrada.

12W
800 lumens
LANÇAMENTO

PAINEL

17x17cm

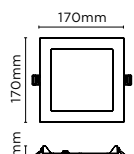

Dimensão do corte:
155x155mm

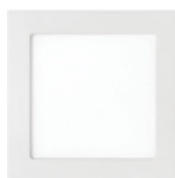

STH9952Q/30 - BIVOLT	3000K	800lm
STH9952Q/40 - BIVOLT	4000K	830lm
STH9952Q/65 - BIVOLT	6500K	850lm

Tensão	100-240V
Eficiência luminosa	67lm/W a 71lm/W
Ângulo de abertura	120°
IRC	>70
Vida útil (L70)	25.000h
Material predominante	Polycarbonato

Inclusas presilhas para fixação.
Fonte integrada.

18W

1200 lumens

LANÇAMENTO

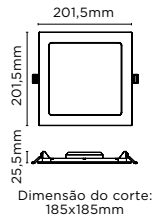

PAINEL

20,15x20,15cm

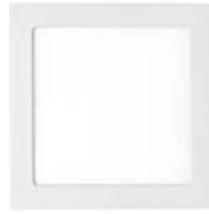

STH9953Q/30 - BIVOLT	3000K	1200lm
STH9953Q/40 - BIVOLT	4000K	1230lm
STH9953Q/65 - BIVOLT	6500K	1250lm

Tensão	100-240V
Eficiência luminosa	67lm/W a 69lm/W
Ângulo de abertura	120°
IRC	>70
Vida útil (L70)	25.000h
Material predominante	Polycarbonato

Inclusas presilhas para fixação.
Fonte integrada.

24W

1700 lumens

LANÇAMENTO

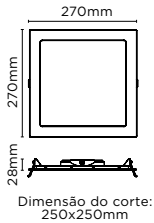

PAINEL

27x27cm

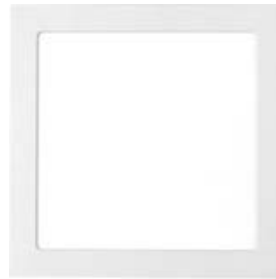

STH9954Q/30 - BIVOLT	3000K	1700lm
STH9954Q/40 - BIVOLT	4000K	1730lm
STH9954Q/65 - BIVOLT	6500K	1750lm

Tensão	100-240V
Eficiência luminosa	71lm/W a 73lm/W
Ângulo de abertura	120°
IRC	>70
Vida útil (L70)	25.000h
Material predominante	Polycarbonato

Inclusas presilhas para fixação.
Fonte integrada.

24W

1700 lumens

LANÇAMENTO

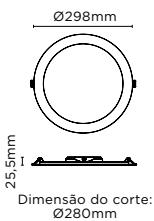

PAINEL

Ø29,8cm



STH9954R/30 - BIVOLT	3000K	1700lm
STH9954R/40 - BIVOLT	4000K	1730lm
STH9954R/65 - BIVOLT	6500K	1750lm

Tensão	100-240V
Eficiência luminosa	71lm/W a 73lm/W
Ângulo de abertura	120°
IRC	>70
Vida útil (L70)	25.000h
Material predominante	Polycarbonato

Inclusas presilhas para fixação.
Fonte integrada.

30W

2000 lumens

LANÇAMENTO

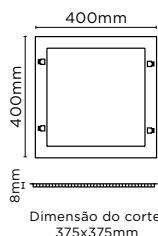

PAINEL

40x40cm



STH7957/30 - BIVOLT	3000K	2000lm
STH7957/40 - BIVOLT	4000K	2000lm
STH7957/57 - BIVOLT	5700K	2000lm

Tensão	100-240V
Eficiência luminosa	67lm/W
Ângulo de abertura	120°
IRC	>80
Vida útil (L70)	25.000h
Material predominante	Alumínio

Inclusas presilhas para fixação e fonte.

**40W**

3400 lumens

PAINEL

62x62cm

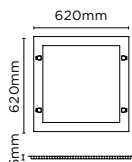
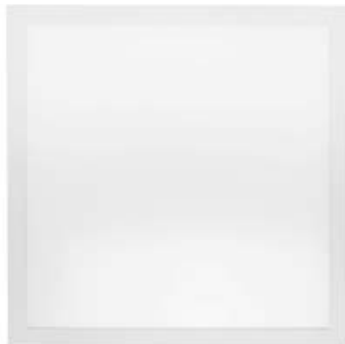
Dimensão do corte:
600x600mm

STH7958/30 - BIVOLT	3000K	3400lm
STH7958/40 - BIVOLT	4000K	3400lm
STH7958/57 - BIVOLT	5700K	3400lm

Tensão	100-240V
Eficiência luminosa	85lm/W
Ângulo de abertura	160°
IRC	>80
Vida útil (L70)	25.000h
Material predominante	Alumínio

Inclusas presilhas para fixação e fonte.

40W

2400 lumens

LANÇAMENTO

PAINEL

15x122cm

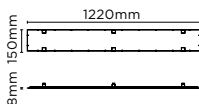
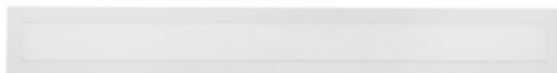
Dimensão do corte:
130x1200mm

STH9956/30 - BIVOLT	3000K	2400lm
STH9956/40 - BIVOLT	4000K	2400lm

Tensão	100-240V
Eficiência luminosa	60lm/W
Ângulo de abertura	120°
IRC	>80
Vida útil (L70)	25.000h
Material predominante	Alumínio

Inclusas presilhas para fixação e fonte.

40W

3400 lumens

PAINEL

32x122cm

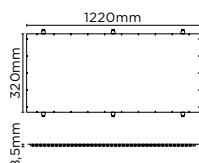
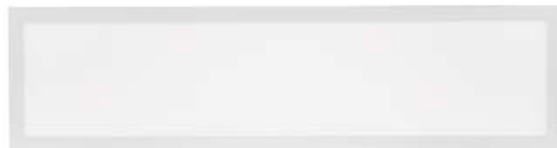
Dimensão do corte:
300x1200mm

STH7959/40 - BIVOLT	4000K	3400lm
---------------------	-------	--------

Tensão	100-240V
Eficiência luminosa	85lm/W
Ângulo de abertura	160°
IRC	>80
Vida útil (L70)	25.000h
Material predominante	Alumínio

Inclusas presilhas para fixação e fonte.

12W

760 lumens

PAINEL SOBREPOR

17x17cm

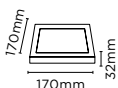

STH8962Q/30 - BIVOLT	3000K	760lm
STH8962Q/40 - BIVOLT	4000K	780lm
STH8962Q/65 - BIVOLT	6500K	800lm

Tensão	100-240V
Eficiência luminosa	63lm/W a 67lm/W
Ângulo de abertura	112°
IRC	>70
Vida útil (L70)	25.000h
Material predominante	Alumínio

Fonte inclusa.

18W
1200 lumens

PAINEL SOBREPOR

22,5x22,5cm

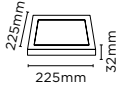

STH8963Q/30 - BIVOLT	3000K	1200lm
STH8963Q/40 - BIVOLT	4000K	1250lm
STH8963Q/65 - BIVOLT	6500K	1300lm

Tensão	100-240V
Eficiência luminosa	67lm/W a 72lm/W
Ângulo de abertura	112°
IRC	>70
Vida útil (L70)	25.000h
Material predominante	Alumínio

Fonte inclusa.

24W
1600 lumens

PAINEL SOBREPOR

30x30cm

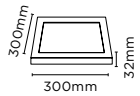

STH8964Q/30 - BIVOLT	3000K	1600lm
STH8964Q/40 - BIVOLT	4000K	1700lm
STH8964Q/65 - BIVOLT	6500K	1800lm

Tensão	100-240V
Eficiência luminosa	67lm/W a 75lm/W
Ângulo de abertura	112°
IRC	>70
Vida útil (L70)	25.000h
Material predominante	Alumínio

Fonte inclusa.

30W
2000 lumens

PAINEL SOBREPOR

40x40cm

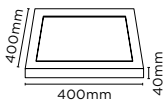

STH7967/30 - BIVOLT	3000K	2000lm
STH7967/40 - BIVOLT	4000K	2000lm
STH7967/57 - BIVOLT	5700K	2000lm

Tensão	100-240V
Eficiência luminosa	67lm/W
Ângulo de abertura	120°
IRC	>80
Vida útil (L70)	25.000h
Material predominante	Alumínio

Fonte inclusa.

40W
3000 lumens

PAINEL SOBREPOR

59,5x59,5cm

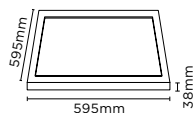

STH7968/30 - BIVOLT	3000K	3000lm
STH7968/40 - BIVOLT	4000K	3000lm
STH7968/57 - BIVOLT	5700K	3000lm

Tensão	100-240V
Eficiência luminosa	75lm/W
Ângulo de abertura	120°
IRC	>80
Vida útil (L70)	25.000h
Material predominante	Alumínio

Fonte inclusa.

PERFIL

Agora com conexões diversas prontas para instalação

Luz retilínea

Próprio para efeitos de luz diferenciados

Fita Full LED integrada

Utilizar somente com fonte 24Vcc Stella, adquirida separadamente.



Produto Stella - Perfil de Sobrepor Linie | Arquitetas: Ana Carolina Moura, Antonia Schneider e Camilla Souza | Mostra EliteDesign 2018
Foto: RPD&S Imagens

12W/m

PERFIL DE SOBREPOR LINIE

520 lumens/m

PRODUTO PRO

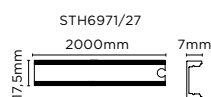
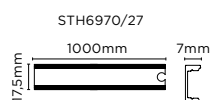

STH6970/27 - 24Vcc - 1m	2700K	520lm
STH6971/27 - 24Vcc - 2m	2700K	1040lm

Potência 1m	12W
Potência 2m	24W
Tensão	24Vcc
IRC	>90
Vida útil (L70)	25.000h
Material predominante	Alumínio

Permite corte a cada 5cm, conforme a marcação de corte da fita.

Inclusos suportes para fixação/emenda e terminais de acabamento.

12W/m

PERFIL DE EMBUTIR LINIE

400 lumens/m

PRODUTO PRO

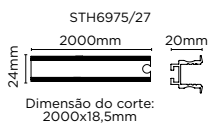
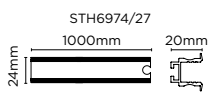

STH6974/27 - 24Vcc - 1m	2700K	400lm
STH6975/27 - 24Vcc - 2m	2700K	800lm

Potência 1m	12W
Potência 2m	24W
Tensão	24Vcc
IRC	>90
Vida útil (L70)	25.000h
Material predominante	Alumínio

Permite corte a cada 5cm, conforme a marcação de corte da fita.

Inclusos terminais de acabamento e presilhas para fixação.

24W/m

PERFIL DE EMBUTIR LINIE

620 lumens/m

PRODUTO PRO



STH6978/27 - 24Vcc - 1m	2700K	620lm
STH6979/27 - 24Vcc - 2m	2700K	1240lm

Potência 1m	24W
Potência 2m	48W
Tensão	24Vcc
IRC	>90
Vida útil (L70)	25.000h
Material predominante	Alumínio

Permite corte a cada 5cm, conforme a marcação de corte das fitas.

Inclusos terminais de acabamento e presilhas para fixação.

ACESSÓRIOS PARA PERFIS LINIE

2,4W 65 lumens LANÇAMENTO	CONEXÃO L PARA PERFIL DE EMBUTIR 12W/m	2,4W 60 lumens LANÇAMENTO	CONEXÃO L TETO-PAREDE PARA PERFIL DE EMBUTIR 12W/m
	STH9984/27 - 24Vcc 2700K 65lm Material predominante: Alumínio		STH9985/27 - 24Vcc 2700K 60lm Material predominante: Alumínio
 Dimensão do corte: 18,5x113mm		 Dimensão do corte: 18,5x94mm	

4,8W 100 lumens LANÇAMENTO	CONEXÃO L PARA PERFIL DE EMBUTIR 24W/m	4,8W 75 lumens LANÇAMENTO	CONEXÃO L TETO-PAREDE PARA PERFIL DE EMBUTIR 24W/m
	STH9988/27 - 24Vcc 2700K 100lm Material predominante: Alumínio		STH9989/27 - 24Vcc 2700K 75lm Material predominante: Alumínio
 Dimensão do corte: 36,5x136mm		 Dimensão do corte: 36,5x77mm	



TERMINAL
PARA PERFIL DE
SOBREPOR LINIE

STH6972

Indicado para os perfis:
STH6970/27
STH6971/27



TERMINAL
PARA PERFIL DE
EMBUTIR LINIE

STH6973

Indicado para os perfis:
STH6974/27
STH6975/27



TERMINAL
PARA PERFIL DE
EMBUTIR LINIE

STH6976

Indicado para os perfis:
STH6978/27
STH6979/27

INDICAÇÃO DE USO DE FONTES PARA PERFIS LED

Perfis Linie 24Vcc Referência/Potência	FONTES		
	STH6894 15W	STH8895 25W	STH6896 60W
STH6970/27 - 1 metro (12W) STH6971/27 - 2 metros (24W)	1 fonte 2 fontes	- 1 fonte	- -
STH6974/27 - 1 metro (12W) STH6975/27 - 2 metros (24W)	1 fonte 2 fontes	- -	- -
STH6978/27 - 1 metro (24W) STH6979/27 - 2 metros (48W)	- -	1 fonte 2 fontes	- 1 fonte

Selecione as fontes adequadas ao seu projeto somando a potência (W) de cada perfil e conexão utilizados. A potência total nunca deve ultrapassar a potência máxima da fonte. Se isto acontecer, utilize mais fontes. O quadro acima informa apenas as fontes com dimensões compatíveis com o nicho de cada perfil. É possível utilizar uma fonte maior do que a informada no quadro, porém, deve-se prever um local para a sua instalação. As fontes Stella permitem a utilização de 100% de sua potência total, diferentemente do que ocorre em fontes de outras marcas, que indicam utilização de apenas 70% a 80% da capacidade total. Ou seja, você realmente pode ligar 100W em uma fonte Stella de 100W.



Produto Stella - Mini Embutido para Móveis Prata | Arquiteta: Adriana Klaus
 Mostra EliteDesign 2018 | Foto: RPD015 Imagens

PLAFON QUADRAT EMBUTIDO P/ MÓVEIS LUMINÁRIA FLAT EMBUTIDO EASY

QUADRAT MR16 PLAFON DIRECIONÁVEL

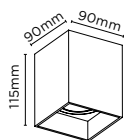

STH8981BR	BRANCO
STH8981PTO	PRETO

Tipo de lâmpada / Base	MR16 / GU10
Potência máxima	15W
Tensão	127V ou 220V
Material	Alumínio

Incluso soquete GU10. Não acompanha lâmpada.
Indicamos o uso de lâmpada LED Stella.

QUADRAT MR16 PLAFON

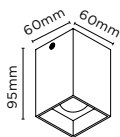

STH8992BR	BRANCO
STH8992PTO	PRETO

Tipo de lâmpada / Base	MR16 / GU10
Potência máxima	15W
Tensão	127V ou 220V
Material	Alumínio

Incluso soquete GU10. Não acompanha lâmpada.
Indicamos o uso de lâmpada LED Stella.

1,2W

80
lumens

MINI EMBUTIDO PARA MÓVEIS FACHO DIRECIONADO 30°

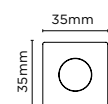

Profundidade: 28,5mm
Dimensão do corte:
Ø29mm



STH6900/30 - BRANCO - BIVOLT	3000K	80lm
STH6901/30 - PRETO - BIVOLT	3000K	80lm
STH6902/30 - PRATA - BIVOLT	3000K	80lm

Tensão	100-240V
Eficiência luminosa	67lm/W
Ângulo de abertura	30°
IRC	>80
Vida útil (L70)	20.000h
Material	Policarbonato

Fonte integrada.

2W

120 lumens

EMBUTIDO PARA MÓVEIS

FACHO DIFUSO 120°

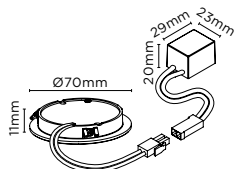

Dimensão do corte:
Ø64mm



STH7905/30 - BRANCO - BIVOLT	3000K	120lm
STH7906/30 - PRATA - BIVOLT	3000K	120lm

Tensão	100-240V
Eficiência luminosa	60lm/W
Ângulo de abertura	120°
IRC	>70
Vida útil (L70)	30.000h
Material	Plástico (PBT)

Fonte inclusa.



BASE SOBREPOR EMBUTIDO PARA MÓVEIS

STH7998	BRANCO
STH7999	PRATA

Contém 1 unidade
Material Plástico (PBT)

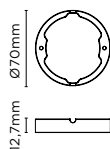

KIT SUSPENSÃO PARA LUMINÁRIA FLAT

STH6999

Contém:
- 2 presilhas,
- 1 anel de acabamento,
- 6cm de termo retrátil,
- 2m de cabo de alimentação,
- 1 par de cabo de aço (1,5m cada).

18W

1400 lumens

LUMINÁRIA FLAT 60cm

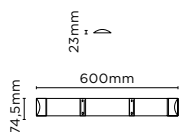

STH7930/30 - BIVOLT	3000K	1400lm
STH7930/40 - BIVOLT	4000K	1400lm
STH7930/57 - BIVOLT	5700K	1400lm

Tensão	100-240V
Eficiência luminosa	78lm/W
Ângulo de abertura	115°
IRC	>70
Vida útil (L70)	25.000h
Material	Policarbonato

Inclusas presilhas para fixação.

36W

2800 lumens

LUMINÁRIA FLAT 120cm

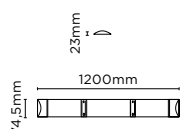

STH7940/30 - BIVOLT	3000K	2800lm
STH7940/40 - BIVOLT	4000K	2800lm
STH7940/57 - BIVOLT	5700K	2800lm

Tensão	100-240V
Eficiência luminosa	78lm/W
Ângulo de abertura	115°
IRC	>70
Vida útil (L70)	25.000h
Material	Policarbonato

Inclusas presilhas para fixação.

**3W**

200 lumens

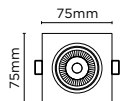
EMBUTIDO EASY MR11
DIRECIONÁVELProfundidade: 45mm
Dimensão do corte: Ø55mm

STH7910/30 - BIVOLT | 3000K | 200lm

Tensão	100-240V
Eficiência luminosa	67lm/W
Intensidade luminosa	385cd
Ângulo de abertura	38°
IRC	>80
Vida útil (L70)	25.000h
Material predominante	Plástico (ABS)

Fonte integrada.

4,5W

300 lumens

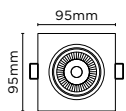
EMBUTIDO EASY MR16
DIRECIONÁVELProfundidade: 45mm
Dimensão do corte: Ø70mm

STH7915/30 - BIVOLT | 3000K | 300lm

Tensão	100-240V
Eficiência luminosa	67lm/W
Intensidade luminosa	730cd
Ângulo de abertura	38°
IRC	>80
Vida útil (L70)	25.000h
Material predominante	Plástico (ABS)

Fonte integrada.

7W

500 lumens

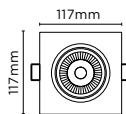
EMBUTIDO EASY PAR20
DIRECIONÁVELProfundidade: 52mm
Dimensão do corte: Ø90mm

STH7920/30 - BIVOLT | 3000K | 500lm

Tensão	100-240V
Eficiência luminosa	71lm/W
Intensidade luminosa	1090cd
Ângulo de abertura	30°
IRC	>80
Vida útil (L70)	25.000h
Material predominante	Plástico (ABS)

Fonte integrada.

12W

800 lumens

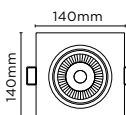
EMBUTIDO EASY PAR30
DIRECIONÁVELProfundidade: 59mm
Dimensão do corte: Ø118mm

STH7925/30 - BIVOLT | 3000K | 800lm

Tensão	100-240V
Eficiência luminosa	67lm/W
Intensidade luminosa	1440cd
Ângulo de abertura	30°
IRC	>80
Vida útil (L70)	25.000h
Material predominante	Plástico (ABS)

Fonte integrada.



Produto Stella: Embutido de Solo Focco Grid 12° | Foto: RPDOIS Imagens

JARDIM

- 52 ARANDELA
- 56 BALIZADOR
- 61 PROJETOR
- 62 ESPETO
- 63 SPOT
- 64 CABO PORTA-LÂMPADAS
- 65 LÂMPADA PARA USO EXTERNO
- 66 SPOT EXTERNO
- 67 EMBUTIDO DE SOLO

Os gráficos luminotécnicos de todos os produtos estão disponíveis no capítulo Gráficos deste catálogo e no site stella.com.br, onde também consta o tempo de garantia de cada produto.



REFLEX

Fonte luminosa e eletrônica integradas em um design surpreendentemente fino

Luz rebatida e indireta

Profundidade de apenas 2,6cm

Fácil instalação e fonte integrada

Sistema de fixação próprio

Solução diferenciada para áreas de entrada



12W

600 lumens

LANÇAMENTO

Ilustração do fecho de luz

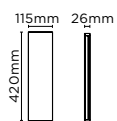

ARANDELA REFLEX

42cm



STH9740BR/30 - BRANCO - BIVOLT	3000K	700lm
STH9740PTO/30 - PRETO - BIVOLT	3000K	600lm

Tensão	100-240V
Eficiência luminosa	50lm/W e 58lm/W
Ângulo de abertura	2x110°
IRC	>80
Vida útil (L70)	25.000h
Grau de proteção	IP65
Material	Alumínio

Fonte integrada.
PATENTE REQUERIDA

20W

1250 lumens

LANÇAMENTO

Ilustração do fecho de luz

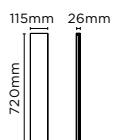

ARANDELA REFLEX

72cm



STH9741BR/30 - BRANCO - BIVOLT	3000K	1400lm
STH9741PTO/30 - PRETO - BIVOLT	3000K	1250lm

Tensão	100-240V
Eficiência luminosa	63lm/W e 70lm/W
Ângulo de abertura	2x110°
IRC	>80
Vida útil (L70)	25.000h
Grau de proteção	IP65
Material	Alumínio

Fonte integrada.
PATENTE REQUERIDA



ARANDELA/BALIZADOR RECOGNIZER

EFEITO DE LUZ
DIFERENCIADO



ARANDELA LICHT

LUZ POR TODOS
OS LADOS

7W
520 lumens

ARANDELA / BALIZADOR RECOGNIZER

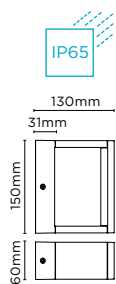

STH5726/30 - BRANCO - BIVOLT	3000K	520lm
STH9726/30 - PRETO - BIVOLT LANÇAMENTO	3000K	460lm

Tensão	100-240V
Eficiência luminosa	65lm/W e 74lm/W
Ângulo de abertura	120°
IRC	>80
Vida útil (L70)	25.000h
Grau de proteção	IP65
Material	Alumínio

Fonte integrada.

5W
450 lumens

ARANDELA LICHT

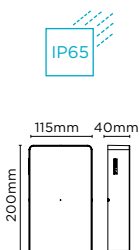

STH7700/30 - BIVOLT	3000K	450lm
STH7700/40 - BIVOLT	4000K	450lm

Tensão	100-240V
Eficiência luminosa	90lm/W
Ângulo de abertura	100°
IRC	>80
Vida útil (L70)	15.000h
Grau de proteção	IP65
Material	Policarbonato

Fonte integrada.

WALL MINI

Engenharia minimalista

Efeitos de luz precisos em um design extremamente compacto

Modelos com fechos abertos e fechados

Possibilidade de combinação de peças para diferentes desenhos de luz

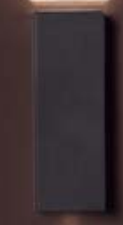

5W

20 lumens

LANÇAMENTO

Ilustração do fecho de luz

WALL MINI ARANDELA 2 FACHOS FECHADOS

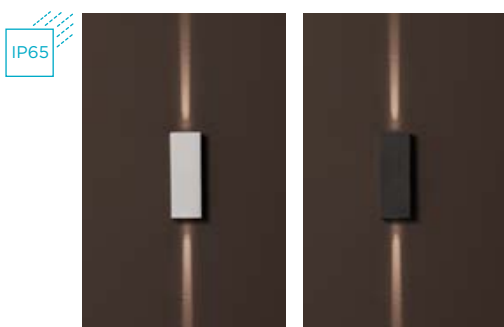

STH9732BR/30 - BRANCO - BIVOLT	3000K	20lm
STH9732PTO/30 - PRETO - BIVOLT	3000K	20lm

Tensão	100-240V
Ângulo de abertura	4° e 4°
IRC	>80
Vida útil (L70)	25.000h
Grau de proteção	IP65
Material	Policarbonato e vidro

Fonte integrada.
Acessório indicado para instalação: STH7799, pág. 57 (não incluso).
PATENTE REQUERIDA

5W

85 lumens

LANÇAMENTO

Ilustração do fecho de luz

WALL MINI ARANDELA 1 FACHO ABERTO - 1 FACHO FECHADO

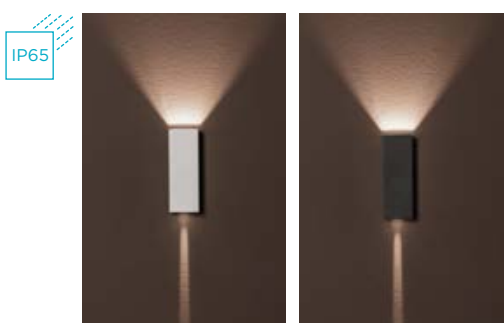

STH9731BR/30 - BRANCO - BIVOLT	3000K	85lm
STH9731PTO/30 - PRETO - BIVOLT	3000K	85lm

Tensão	100-240V
Ângulo de abertura	70° e 4°
IRC	>80
Vida útil (L70)	25.000h
Grau de proteção	IP65
Material	Policarbonato e vidro

Fonte integrada.
Acessório indicado para instalação: STH7799, pág. 57 (não incluso).
PATENTE REQUERIDA

5W

150 lumens

LANÇAMENTO

Ilustração do fecho de luz

WALL MINI

ARANDELA 2 FACHOS ABERTOS

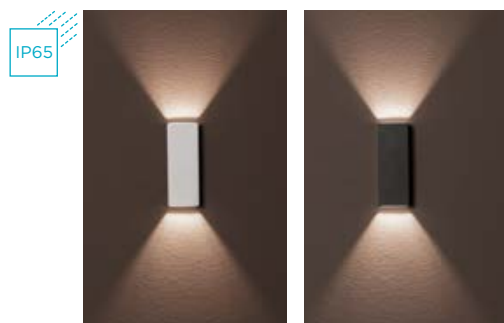

STH9730BR/30 - BRANCO - BIVOLT	3000K	150lm
STH9730PTO/30 - PRETO - BIVOLT	3000K	150lm

Tensão	100-240V
Ângulo de abertura	70° e 70°
IRC	>80
Vida útil (L70)	25.000h
Grau de proteção	IP65
Material	Policarbonato e vidro

Fonte integrada.
 Acessório indicado para instalação: STH7799, pág. 57 (não incluso).
 PATENTE REQUERIDA

4W

240 lumens

IP65

ARANDELA EFFEKT

1 FACHO ABERTO



STH6734/30 - BRANCO - BIVOLT	3000K	240lm
STH6735/30 - PRETO - BIVOLT	3000K	240lm

Tensão	100-240V
Eficiência luminosa	60lm/W
Ângulo de abertura	90°
IRC	>80
Vida útil (L70)	20.000h
Grau de proteção	IP65
Material	Policarbonato

Fonte integrada.

8W

480 lumens

IP65

ARANDELA EFFEKT

2 FACHOS ABERTOS



STH6730/30 - BRANCO - BIVOLT	3000K	480lm
STH6731/30 - PRETO - BIVOLT	3000K	480lm
STH7736/30 - CAFÉ - BIVOLT	3000K	480lm
STH7737/30 - CONCRETO - BIVOLT	3000K	480lm

Tensão	100-240V
Eficiência luminosa	60lm/W
Ângulo de abertura	90° e 90°
IRC	>80
Vida útil (L70)	20.000h
Grau de proteção	IP65
Material	Policarbonato

Fonte integrada.

8W

340 lumens

IP65

ARANDELA EFFEKT

1 FACHO ABERTO - 1 FACHO FECHADO



STH6732/30 - BRANCO - BIVOLT	3000K	340lm
STH6733/30 - PRETO - BIVOLT	3000K	340lm

Tensão	100-240V
Eficiência luminosa	42lm/W
Ângulo de abertura	4° e 90°
IRC	>80
Vida útil (L70)	20.000h
Grau de proteção	IP65
Material	Policarbonato

Fonte integrada.



NEU 2

LUZ PARA ACENTUAR CAMINHOS

1,5W
40 lumens

MINI NEU 2 BALIZADOR SOBREPOR



Ilustração do fecho de luz (vista frontal)

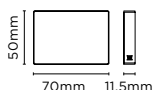

STH8745/30 - BRANCO - BIVOLT	3000K	40lm
STH8746/30 - PRETO - BIVOLT	3000K	40lm

Tensão	100-240V
Eficiência luminosa	27lm/W
Ângulo de abertura	60°
IRC	>80
Vida útil (L70)	25.000h
Grau de proteção	IP65
Material	Polycarbonato

Fonte integrada.
Acessório indicado para instalação: STH7799, pág. 57 (não incluso).
PRODUTO PATENTEADO

2W
50 lumens

NEU 2 BALIZADOR SOBREPOR



Ilustração do fecho de luz (vista lateral)

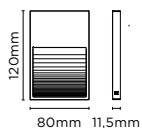

STH8750/30 - BRANCO - BIVOLT	3000K	80lm
STH8751/30 - PRETO - BIVOLT	3000K	50lm

Tensão	100-240V
Eficiência luminosa	40lm/W e 25lm/W
Ângulo de abertura	60°
IRC	>80
Vida útil (L70)	25.000h
Grau de proteção	IP65
Material	Polycarbonato

Fonte integrada.
PRODUTO PATENTEADO

3W
75 lumens

BIG NEU 2 BALIZADOR SOBREPOR



Ilustração do fecho de luz (vista lateral)

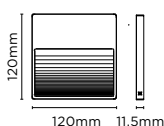

STH8755/30 - BRANCO - BIVOLT	3000K	120lm
STH8756/30 - PRETO - BIVOLT	3000K	75lm

Tensão	100-240V
Eficiência luminosa	40lm/W e 25lm/W
Ângulo de abertura	80°
IRC	>80
Vida útil (L70)	25.000h
Grau de proteção	IP65
Material	Polycarbonato

Fonte integrada.
PRODUTO PATENTEADO

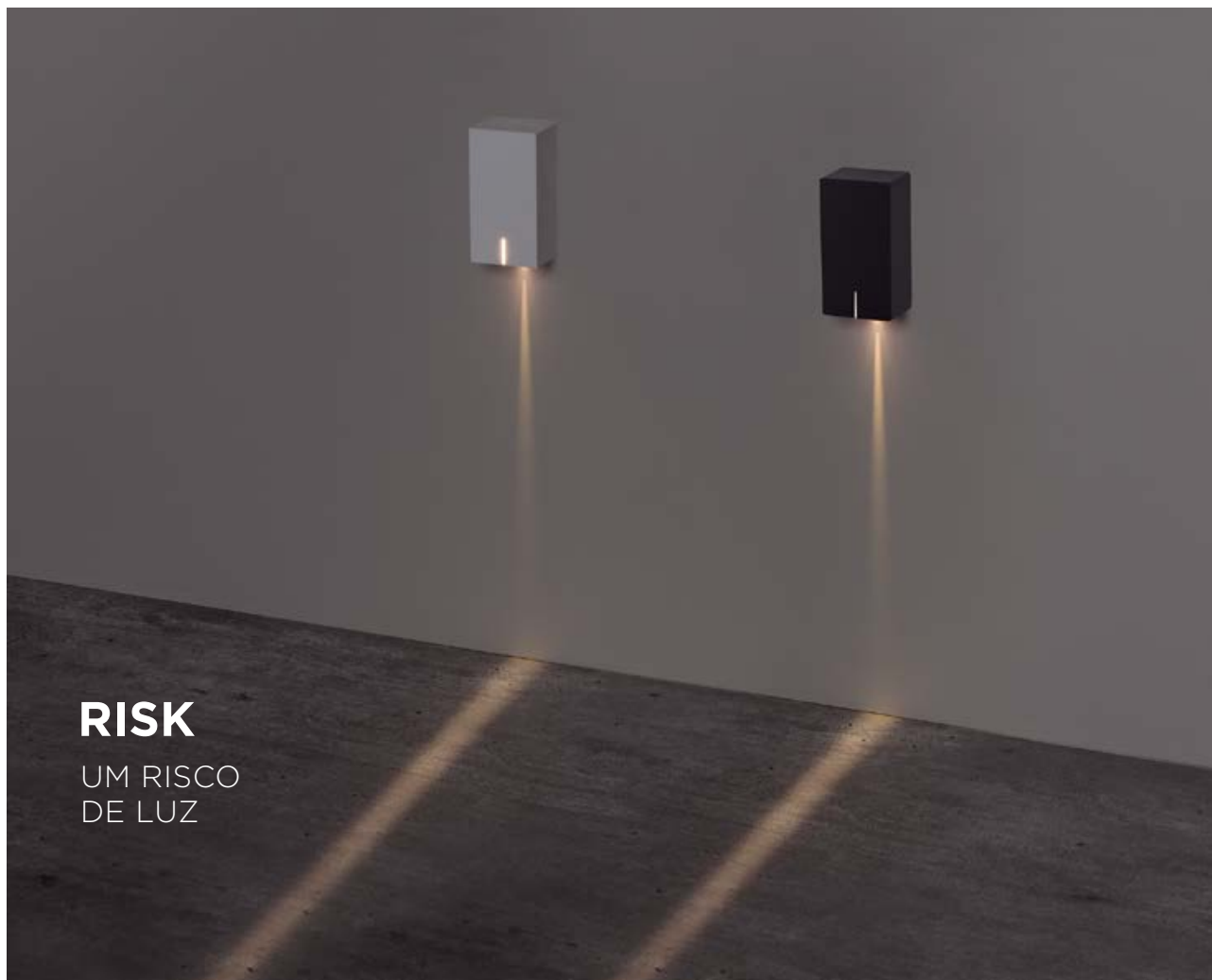

RISK

UM RISCO DE LUZ

3W
5 lumens

RISK BALIZADOR SOBREPOR



Ilustração do fecho de luz

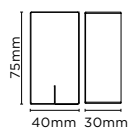

STH8740/30 - BRANCO - BIVOLT	3000K	5lm
STH8741/30 - PRETO - BIVOLT	3000K	5lm

Tensão	100-240V
Ângulo de abertura	5°
IRC	>80
Vida útil (L70)	25.000h
Grau de proteção	IP65
Material	Policarbonato

Fonte integrada.
Acessório indicado para instalação: STH7799, pág. 57 (não incluso).
PRODUTO PATENTEADO

MINI CAIXA DE INSTALAÇÃO PARA WALL MINI, RISK E MINI NEU

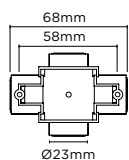
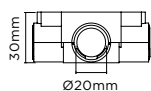

STH7799

Contém	1 unidade
Material	Policarbonato

Utilize apenas mangueiras corrugadas de 1/2 - 20mm
Acessório indicado para utilização em alvenaria.



Ilustração de instalação com Mini Neu 2



BALIZADORES DE EMBUTIR
SPUR
BALIZE

POSTES BALIZADORES
RECOGNIZER
FRANKFURT

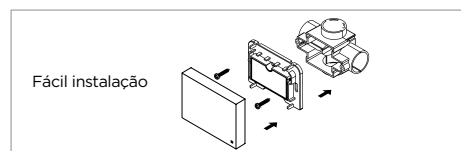
Produtos Stella, Postes, Balizadores Frankfurt
Arquiteto: Estúdio Carlos Fortes | CASACOR PE 2017
Foto: Rogério Maranhão

0,5W
2 lumens

MINI SPUR
BALIZADOR DE SOLO

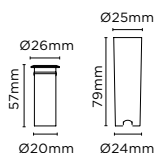

STH8702/27 - BRANCO - BIVOLT	2700K	2lm
STH8703/27 - PRETO - BIVOLT	2700K	2lm
STH8703/AB - PRETO - BIVOLT	ÂMBAR	-

Tensão	100-240V
Ângulo de abertura	100°
IRC 2700K	>70
Vida útil (L70)	25.000h
Grau de proteção	IP67
Material	Alumínio e policarbonato

Incluso tubo plástico.
Fonte integrada.

1W
20 lumens

SPUR LUZ GERAL
BALIZADOR DE SOLO

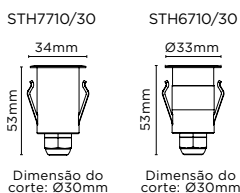

STH7710/30 - BIVOLT	3000K	20lm
STH6710/30 - BIVOLT	3000K	20lm

Tensão	100-240V
Eficiência luminosa	20lm/W
Ângulo de abertura	100°
IRC	>80
Vida útil (L70)	20.000h
Grau de proteção	IP67
Material	Alumínio e policarbonato

Fonte integrada.
Acessório indicado para instalação: STH6791, pág. 59 (não incluso).

2W
80 lumens

SPUR EFEITO
BALIZADOR DE SOLO

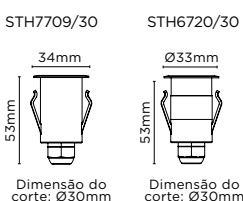

STH7709/30 - BIVOLT	3000K	80lm
STH6720/30 - BIVOLT	3000K	80lm

Tensão	100-240V
Eficiência luminosa	40lm/W
Ângulo de abertura	30°
IRC	>80
Vida útil (L70)	20.000h
Grau de proteção	IP67
Material	Alumínio e policarbonato

Fonte integrada.
Acessório indicado para instalação: STH6791, pág. 59 (não incluso).



TUBO DE PROTEÇÃO PARA BALIZADORES DE SOLO SPUR

STH6791

Contém 1 unidade
Material Policarbonato

Acessório indicado para utilização em alvenaria.

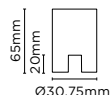

1W
10 lumens

BALIZE 1 E 4 FACHOS EMBUTIDO DE SOLO

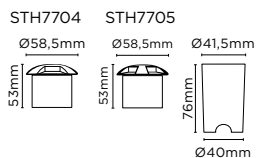

STH7704/30 - 1 FACHO - BIVOLT	3000K	10lm
STH7705/30 - 4 FACHOS - BIVOLT	3000K	15lm

Tensão	100-240V
Eficiência luminosa STH7704/30	10lm/W
Eficiência luminosa STH7705/30	15lm/W
Ângulo de abertura STH7704/30	40°
Ângulo de abertura STH7705/30	4 x 40°
IRC	>80
Vida útil (L70)	25.000h
Grau de proteção	IP67
Material	Alumínio e policarbonato

Incluso tubo plástico.
Fonte integrada.

7W
520 lumens

RECOGNIZER POSTE BALIZADOR

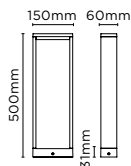

STH5725/30 - BIVOLT | 3000K | 520lm

Tensão	100-240V
Eficiência luminosa	74lm/W
Ângulo de abertura	120°
IRC	>80
Vida útil (L70)	25.000h
Grau de proteção	IP65
Material	Alumínio

Fonte integrada.

7W
520 lumens

FRANKFURT POSTE BALIZADOR

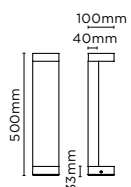

STH5720/30 - BIVOLT | 3000K | 520lm

Tensão	100-240V
Eficiência luminosa	74lm/W
Ângulo de abertura	120°
IRC	>80
Vida útil (L70)	25.000h
Grau de proteção	IP65
Material	Alumínio

Fonte integrada.



LINE

ARANDELA/BALIZADOR

Fonte luminosa recuada

Efeito de luz linear de 4° com baixíssimo ofuscamento

Versátil: aplicação em parede ou solo

Permite uso com Espeto de Fixação

6W
40 lumens
LANÇAMENTO

Ilustração do fecho de luz

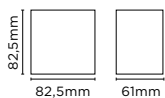

LINE

ARANDELA/BALIZADOR



STH9725BR/30 - BRANCO - BIVOLT	3000K	40lm
STH9725PTO/30 - PRETO - BIVOLT	3000K	40lm

Tensão	100-240V
Ângulo de abertura	4°
IRC	>80
Vida útil (L70)	25.000h
Grau de proteção	IP65
Material	Alumínio

Fonte integrada.
 Acessório indicado: Espetos para Fixação (STH6769, pág. 64, não incluso).
 PATENTE REQUERIDA

3W

BALIZADOR DE EFEITO

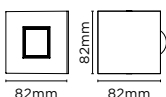

STH4725/30 - BIVOLT	3000K
---------------------	-------

Tensão	100-240V
Intensidade luminosa	240cd
Ângulo de abertura	8°
IRC	>70
Vida útil (L70)	25.000h
Grau de proteção	IP65
Material	Alumínio

Incluso espeto para fixação.
 Fonte integrada.

10W

800 lumens

PROJETOR VERT

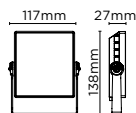

STH7761/30 - BRANCO - BIVOLT	3000K	800lm
STH7741/30 - PRETO - BIVOLT	3000K	800lm
STH7761/65 - BRANCO - BIVOLT	6500K	800lm
STH7741/65 - PRETO - BIVOLT	6500K	800lm

Tensão	100-240V
Eficiência luminosa	80lm/W
Ângulo de abertura	110°
IRC	>80
Vida útil (L70)	25.000h
Grau de proteção	IP65
Material predominante	Alumínio

Fonte integrada.
 Acessório indicado: Espetos para Fixação (STH6769, pág. 64, não incluso).

20W

1600 lumens

PROJETOR VERT

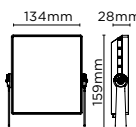

STH7742/30 - PRETO - BIVOLT	3000K	1600lm
STH7742/65 - PRETO - BIVOLT	6500K	1600lm

Tensão	100-240V
Eficiência luminosa	80lm/W
Ângulo de abertura	110°
IRC	>80
Vida útil (L70)	25.000h
Grau de proteção	IP65
Material predominante	Alumínio

Fonte integrada.
 Acessório indicado: Espetos para Fixação (STH6769, pág. 64, não incluso).

30W

2300 lumens

PROJETOR VERT

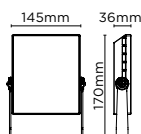

STH7763/30 - BRANCO - BIVOLT	3000K	2300lm
STH7743/30 - PRETO - BIVOLT	3000K	2300lm
STH7763/65 - BRANCO - BIVOLT	6500K	2300lm
STH7743/65 - PRETO - BIVOLT	6500K	2300lm

Tensão	100-240V
Eficiência luminosa	77lm/W
Ângulo de abertura	110°
IRC	>80
Vida útil (L70)	25.000h
Grau de proteção	IP65
Material predominante	Alumínio

Fonte integrada.
 Acessório indicado: Espetos para Fixação (STH6769, pág. 64, não incluso).

50W

3800 lumens

PROJETOR VERT

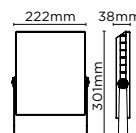

STH7765/30 - BRANCO - BIVOLT	3000K	3800lm
STH7745/30 - PRETO - BIVOLT	3000K	3800lm
STH7765/65 - BRANCO - BIVOLT	6500K	3800lm
STH7745/65 - PRETO - BIVOLT	6500K	3800lm

Tensão	100-240V
Eficiência luminosa	76lm/W
Ângulo de abertura	110°
IRC	>80
Vida útil (L70)	25.000h
Grau de proteção	IP65
Material predominante	Alumínio

Fonte integrada.
 Acessório indicado: Espetos para Fixação (STH6769, pág. 64, não incluso).



Produto Stella: Hide Espeto Quadrado Preto | Foto: RPD01S Imagens

5W
300 lumens

HIDE
ESPETO QUADRADO

STH8723/30 - PRETO - BIVOLT	3000K	300lm
STH8724/30 - CINZA LANÇAMENTO - BIVOLT	3000K	300lm

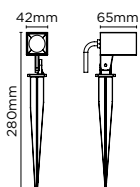

Tensão	100-240V
Eficiência luminosa	60lm/W
Ângulo de abertura	36°
IRC	>80
Vida útil (L70)	25.000h
Grau de proteção	IP67
Material predominante	Alumínio

Fonte integrada.
PRODUTO PATENTEADO

4W

ESPETO MINI

STH5700/AB - BIVOLT ¹	LUZ ÂMBAR
STH5700/VD - BIVOLT ¹	LUZ VERDE

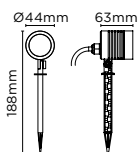

Tensão	100-240V
Ângulo de abertura	25°
Vida útil (L70)	20.000h
Grau de proteção	IP66
Material	Policarbonato

Fonte integrada.
¹ Produto disponível apenas enquanto durarem os estoques.

3W
150 lumens

ESPETO MINI FOCCO

STH7702/30 - BIVOLT	3000K	150lm
---------------------	-------	-------

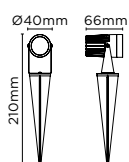

Tensão	100-240V
Eficiência luminosa	50lm/W
Ângulo de abertura	25°
IRC	>80
Vida útil (L70)	25.000h
Grau de proteção	IP67
Material predominante	Alumínio

Fonte integrada.



Produto Stela - Spot Focco com Cinta | Foto: RPD OIS Imagens

SPOT FOCCO COM CINTA

Fixação versátil com sistema de tiras aderentes, permitindo uso em galhos

Solução para iluminação elevada

Permite iluminação de cima para baixo

5W
300 lumens
LANÇAMENTO

SPOT FOCCO COM CINTA

STH9720/30 - BIVOLT	3000K	300lm
----------------------------	-------	-------

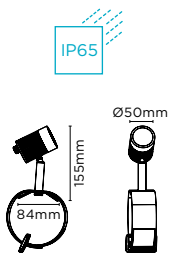

Tensão	100-240V
Eficiência luminosa	60lm/W
Ângulo de abertura	25°
IRC	>80
Vida útil (L70)	25.000h
Grau de proteção	IP65
Material predominante	Alumínio

Fonte integrada.

7W
450 lumens

SPOT FOCCO

STH7701/30 - BIVOLT	3000K	450lm
----------------------------	-------	-------

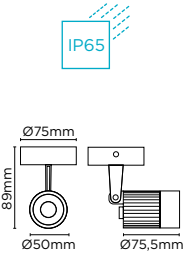

Tensão	100-240V
Eficiência luminosa	64lm/W
Ângulo de abertura	25°
IRC	>80
Vida útil (L70)	25.000h
Grau de proteção	IP65
Material predominante	Alumínio

Fonte integrada.

7W
450 lumens

ESPETO FOCCO

STH7703/30 - BIVOLT	3000K	450lm
----------------------------	-------	-------

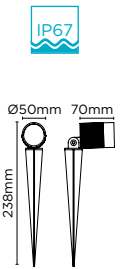

Tensão	100-240V
Eficiência luminosa	64lm/W
Ângulo de abertura	25°
IRC	>80
Vida útil (L70)	25.000h
Grau de proteção	IP67
Material predominante	Alumínio

Fonte integrada.

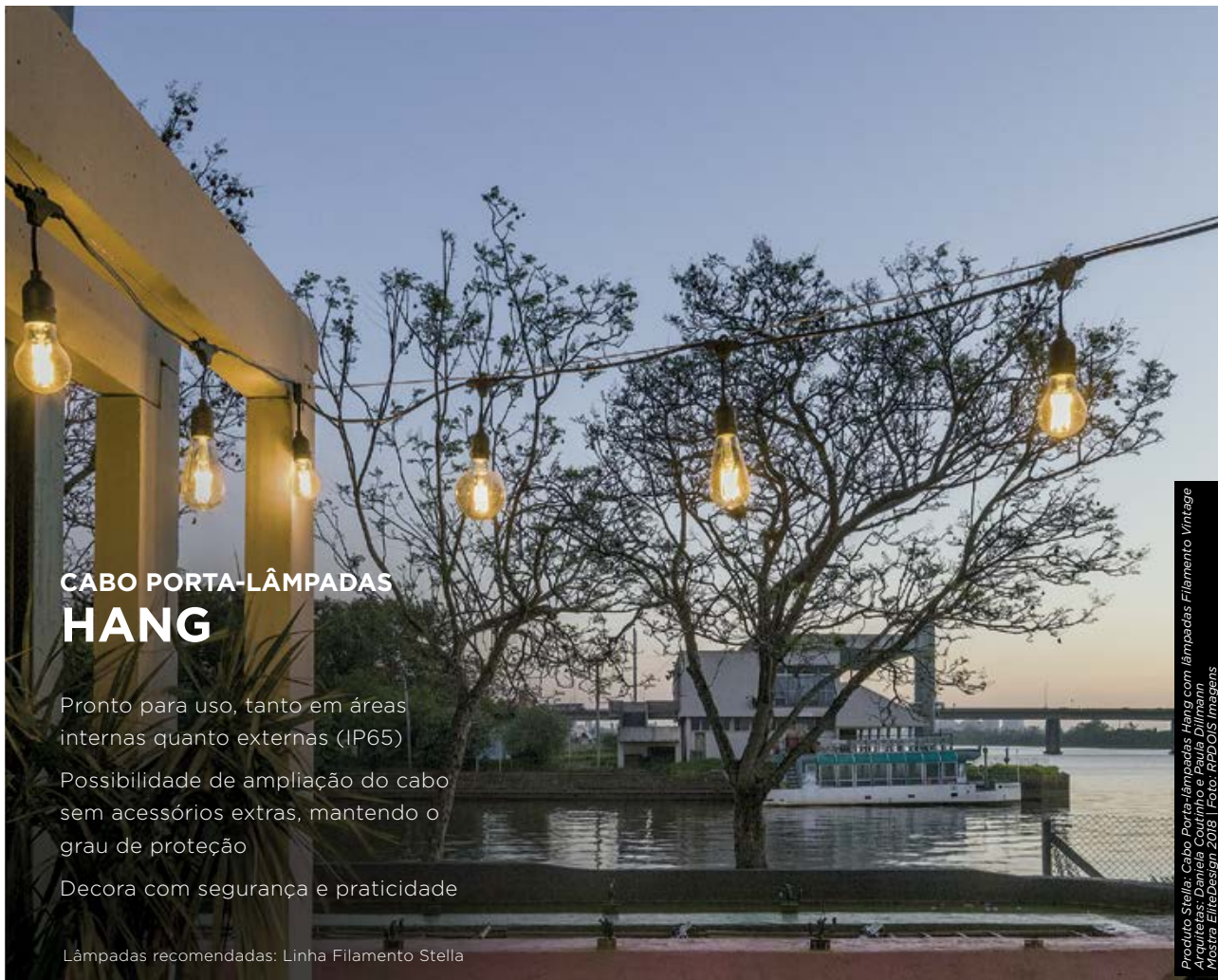

CABO PORTA-LÂMPADAS HANG

Pronto para uso, tanto em áreas internas quanto externas (IP65)

Possibilidade de ampliação do cabo sem acessórios extras, mantendo o grau de proteção

Decora com segurança e praticidade

Lâmpadas recomendadas: Linha Filamento Stella

Produto Stella - Cabo Porta-lâmpadas Hang com lâmpadas Filamento Vintage
Arquitetas: Daniela Coutinho e Paula Dillmann
Mostra EliteDesign 2018 | Foto: RPD&S Imagens

CABO PORTA-LÂMPADAS HANG



STH7099

Base	E27
Potência máxima por extensão contínua	500W
Número de soquetes	8
Material predominante	PVC
Comprimento com conector	5,5m

Lâmpada indicada: Filamento Stella.

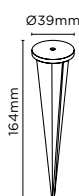
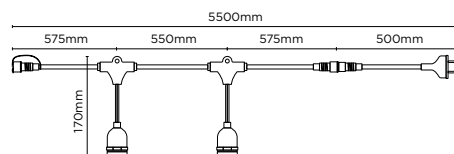

ESPETOS PARA FIXAÇÃO

STH6769

Contém	2 unidades
Material	Alumínio

LÂMPADAS PARA USO EXTERNO

7W

PAR20 VIDRO

560
lumens

IP65*

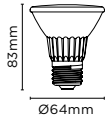

STH6080/27 - BIVOLT	2700K	560lm
---------------------	-------	-------

Base	E27
Tensão	100-240V
Eficiência luminosa	80lm/W
Intensidade luminosa	600cd
Ângulo de abertura	45°
IRC	>80
Vida útil (L70)	25.000h
Grau de proteção	IP65

*Para uso externo, é obrigatória a utilização em luminárias com a correta vedação (IP65) ou superior, vide manual.

7W

PAR20 COLOR VIDRO

IP65*

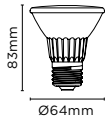

STH6090/AB - BIVOLT	LUZ ÂMBAR
---------------------	-----------

STH6090/AZ - BIVOLT	LUZ AZUL
---------------------	----------

STH6090/VD - BIVOLT	LUZ VERDE
---------------------	-----------

Base	E27
Tensão	100-240V
Ângulo de abertura	45°
Vida útil (L70)	20.000h
Grau de proteção	IP65

*Para uso externo, é obrigatória a utilização em luminárias com a correta vedação (IP65) ou superior, vide manual.

18W

PAR38 COLOR VIDRO

IP65*



STH6093/AB - BIVOLT	LUZ ÂMBAR
---------------------	-----------

STH6093/AZ - BIVOLT	LUZ AZUL
---------------------	----------

STH6093/VD - BIVOLT	LUZ VERDE
---------------------	-----------

Base	E27
Tensão	100-240V
Ângulo de abertura	45°
Vida útil (L70)	20.000h
Grau de proteção	IP65

*Para uso externo, é obrigatória a utilização em luminárias com a correta vedação (IP65) ou superior, vide manual.

6W

PAR20 COLOR

IP65*

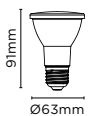

STH7090/AB ¹ - BIVOLT	LUZ ÂMBAR
----------------------------------	-----------

STH7090/VD ¹ - BIVOLT	LUZ VERDE
----------------------------------	-----------

Base	E27
Tensão	100-240V
Ângulo de abertura	38°
Vida útil (L70)	25.000h
Grau de proteção	IP65

*Para uso externo, é obrigatória a utilização em luminárias com a correta vedação (IP65) ou superior, vide manual.
¹ Produto disponível apenas enquanto durarem os estoques.



Produto: Stella Cube Spot Externo Preto | Foto: RPDOS Imagens

CUBE

Transforma embutidos de solo em luminárias

Permite iluminação destacada com elevação do solo

Luz livre de obstáculos visuais da vegetação rasteira

Pintura eletrostática e alça com sistema de travamento

Para solo, parede e teto em ambientes internos e externos

CUBE SPOT EXTERNO

LANÇAMENTO

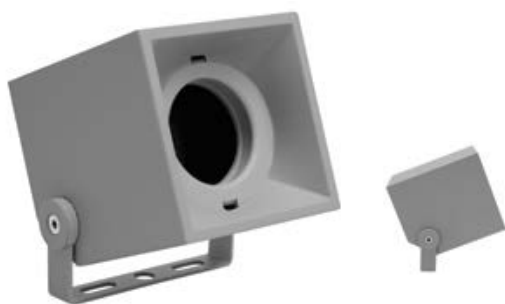
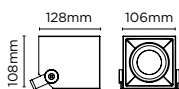

STH8701 - CINZA

Material **Alumínio**

O spot externo Cube é compatível com os embutidos de solo Focco de 5W e 10W (redondos).

- Focco Grid: STH8716/30 | STH8717/30
- Focco Inox: STH8706/30 | STH8707/30
- Focco: STH7706/30 | STH7707/30

Embutidos de solo vendidos separadamente.

IP compatível com o embutido de solo.

PRODUTO PATENTEADO

CUBE SPOT EXTERNO

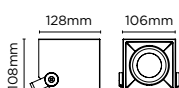

STH8700 - PRETO

Material **Alumínio**

O spot externo Cube é compatível com os embutidos de solo Focco de 5W e 10W (redondos).

- Focco Grid: STH8716/30 | STH8717/30
- Focco Inox: STH8706/30 | STH8707/30
- Focco: STH7706/30 | STH7707/30

Embutidos de solo vendidos separadamente.

IP compatível com o embutido de solo.

PRODUTO PATENTEADO

5W

240 lumens



Este produto é compatível com o Spot Cube.

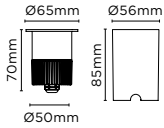

FOCCO GRID 12°
 EMBUTIDO DE SOLO COM GRADE ANTIOFUSCANTE

STH8716/30 - BIVOLT	3000K	240lm
---------------------	-------	-------



Tensão	100-240V
Eficiência luminosa	48lm/W
Intensidade luminosa	2500cd
Ângulo de abertura	12°
IRC	>80
Vida útil (L70)	25.000h
Grau de proteção	IP67
Material	Alumínio

Incluso tubo plástico.
 Fonte integrada.

10W

400 lumens



Este produto é compatível com o Spot Cube.

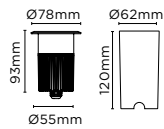

FOCCO GRID 12°
 EMBUTIDO DE SOLO COM GRADE ANTIOFUSCANTE

STH8717/30 - BIVOLT	3000K	400lm
---------------------	-------	-------



Tensão	100-240V
Eficiência luminosa	40lm/W
Intensidade luminosa	5000cd
Ângulo de abertura	12°
IRC	>80
Vida útil (L70)	25.000h
Grau de proteção	IP67
Material	Alumínio

Incluso tubo plástico.
 Fonte integrada.

18W

800 lumens

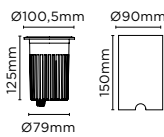

FOCCO GRID 12°
 EMBUTIDO DE SOLO COM GRADE ANTIOFUSCANTE

STH8719/30 - BIVOLT	3000K	800lm
---------------------	-------	-------



Tensão	100-240V
Eficiência luminosa	44lm/W
Intensidade luminosa	10000cd
Ângulo de abertura	12°
IRC	>80
Vida útil (L70)	25.000h
Grau de proteção	IP67
Material	Alumínio

Incluso tubo plástico.
 Fonte integrada.

5W

320 lumens



Este produto é compatível com o Spot Cube.

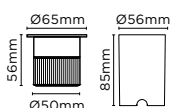

FOCCO 30°
 EMBUTIDO DE SOLO

STH8706/30 - INOX - BIVOLT	3000K	320lm
----------------------------	-------	-------

STH7706/30 - PRETO - BIVOLT	3000K	320lm
-----------------------------	-------	-------



STH8706



STH7706

Tensão	100-240V
Eficiência luminosa	64lm/W
Intensidade luminosa	1200cd
Ângulo de abertura	30°
IRC	>80
Vida útil (L70)	25.000h
Grau de proteção	IP67
Material	Alumínio

Incluso tubo plástico.
 Fonte integrada.



10W

640 lumens



Este produto é compatível com o Spot Cube.

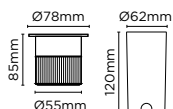

FOCCO 30° EMBUTIDO DE SOLO



STH8707



STH7707

STH8707/30 - INOX - BIVOLT	3000K	640lm
STH7707/30 - PRETO - BIVOLT	3000K	640lm

Tensão	100-240V
Eficiência luminosa	64lm/W
Intensidade luminosa	1700cd
Ângulo de abertura	30°
IRC	>80
Vida útil (L70)	25.000h
Grau de proteção	IP67
Material	Alumínio

Incluso tubo plástico.
Fonte integrada.

10W

640 lumens

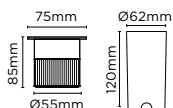

FOCCO 30° EMBUTIDO DE SOLO



STH8708



STH7708

STH8708/30 - INOX - BIVOLT	3000K	640lm
STH7708/30 - PRETO - BIVOLT	3000K	640lm

Tensão	100-240V
Eficiência luminosa	64lm/W
Intensidade luminosa	1700cd
Ângulo de abertura	30°
IRC	>80
Vida útil (L70)	25.000h
Grau de proteção	IP67
Material	Alumínio

Incluso tubo plástico.
Fonte integrada.

18W

1300 lumens

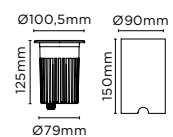

FOCCO 30° EMBUTIDO DE SOLO



STH8709/30 - BIVOLT	3000K	1300lm
---------------------	-------	--------

Tensão	100-240V
Eficiência luminosa	3000cd
Intensidade luminosa	72lm/W
Ângulo de abertura	30°
IRC	>80
Vida útil (L70)	25.000h
Grau de proteção	IP67
Material	Alumínio

Incluso tubo plástico.
Fonte integrada.

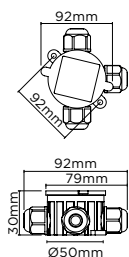

CAIXA DE PASSAGEM IP68

STH9799

LANÇAMENTO

Contém	1 unidade
Material	Policarbonato

Própria para instalações que requerem emendas abaixo do solo. Indicado somente para uso com cabo PP de 5mm a 8mm de diâmetro externo.



Produtos Stella: Fita 12V e Spot Voll | Arquiteta: Betina Tessmann Schmidt | Mostra Glass House Design 2017 | Foto: Studio Denise Wichmann

FITAS

- 70 FITA 12V
- 72 FITA 24V
- 73 FITA TENSÃO DE REDE
- 74 FITA LED TENSÃO DE REDE NEON
- 75 ACESSÓRIOS E FONTES PARA FITA 12V
- 77 ACESSÓRIOS E FONTES PARA FITA 24V
- 79 ACESSÓRIOS PARA FITA RGBW
- 80 ACESSÓRIOS PARA FITA TENSÃO DE REDE
- 81 ACESSÓRIOS PARA FITA LED TENSÃO DE REDE NEON
- 82 DIAGRAMAS DE INSTALAÇÕES

O tempo de garantia de cada produto está disponível no site stella.com.br.



FITA 12V

Variedade de temperaturas de cor e opções de luz âmbar e azul

Permite controle da intensidade da luz com fonte dimerizável

Utilizar somente com fonte 12Vcc Stella, adquirida separadamente.

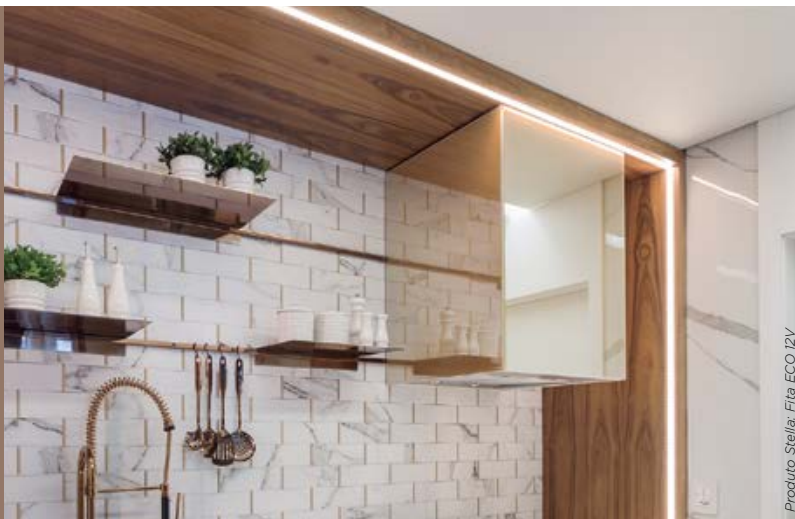

Produto Stella: Fita ECO 12V

5W/m

400 lumens/m

FITA ECO 12V

ROLO 5m

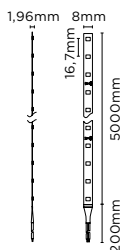

STH7804/27 - 12Vcc - IP20	2700K	400lm/m
STH7805/27 - 12Vcc - IP65	2700K	400lm/m
STH7804/40 - 12Vcc - IP20	4000K	400lm/m
STH7804/65 - 12Vcc - IP20	6500K	400lm/m

Tensão	12Vcc ¹
Potência total	25W
Fluxo luminoso total	2000lm
Especificações	60 LEDs SMD2835/m
IRC	>70
Vida útil (L70)	15.000h

¹ Fontes indicadas: págs. 75 a 77.
Acessórios indicados: conector e emenda para Fita 8mm (pág. 75).
Permite corte a cada 5cm.

10W/m

600 lumens/m

FITA ECO 12V

ROLO 5m

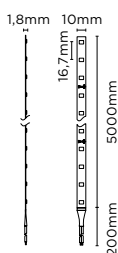

STH7814/27 - 12Vcc - IP20	2700K	600lm/m
STH7815/27 - 12Vcc - IP65	2700K	600lm/m
STH7814/40 - 12Vcc - IP20	4000K	600lm/m
STH7814/65 - 12Vcc - IP20	6500K	600lm/m

Tensão	12Vcc ²
Potência total	50W
Fluxo luminoso total	3000lm
Especificações	60 LEDs SMD5050/m
IRC	>70
Vida útil (L70)	15.000h

² Fontes indicadas: págs. 75 a 77.
Acessórios indicados: conector e emenda para Fita 10mm (pág. 75).
Permite corte a cada 5cm.

6W/m

450 lumens/m

FITA EVO 12V

ROLO 5m

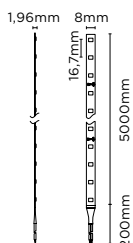

STH7800/24 - 12Vcc - IP20	2400K	450lm/m
STH6800/27 - 12Vcc - IP20	2700K	450lm/m
STH6805/27 - 12Vcc - IP65	2700K	450lm/m
STH8800/30 - 12Vcc - IP20	3000K LANÇAMENTO	450lm/m
STH6800/40 - 12Vcc - IP20	4000K	450lm/m

Tensão	12Vcc ³
Potência total	30W
Fluxo luminoso total	2250lm
Especificações	60 LEDs SMD2835/m
IRC	>80
Vida útil (L70)	25.000h

³ Fontes indicadas: págs. 75 a 77.
Acessórios indicados: conector e emenda para Fita 8mm (pág. 75).
Permite corte a cada 5cm.

12W/m

750 lumens/m

FITA EVO 12V

ROLO 5m

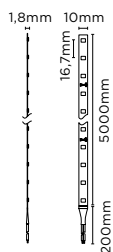

STH6810/27 - 12Vcc - IP20	2700K	750lm/m
STH6815/27 - 12Vcc - IP65	2700K	750lm/m
STH8810/30 - 12Vcc - IP20	3000K LANÇAMENTO	750lm/m
STH6810/40 - 12Vcc - IP20	4000K	750lm/m

Tensão	12Vcc ¹
Potência total	60W
Fluxo luminoso total	3750lm
Especificações	60 LEDs SMD5050/m
IRC	>80
Vida útil (L70)	25.000h

¹ Fontes indicadas: págs. 75 a 77.

Acessórios indicados: conector e emenda para Fita 10mm (pág. 75).

Permite corte a cada 5cm.

6W/m

FITA COLOR 12V

ROLO 5m

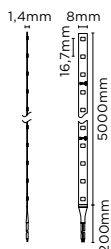

STH6800/AB - 12Vcc - IP20	LUZ ÂMBAR
STH6800/AZ - 12Vcc - IP20	LUZ AZUL

Tensão	12Vcc ²
Potência total	30W
Especificações	60 LEDs SMD2835/m
Vida útil (L70)	25.000h

² Fontes indicadas: págs. 75 a 77.

Acessórios indicados: conector e emenda para Fita 8mm (pág. 75).

Permite corte a cada 5cm.

6W/m

450 lumens/m

KIT FITA

ROLO 2m

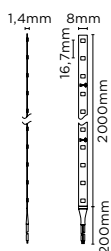

STH6802/27 - BIVOLT	2700K	450lm/m
---------------------	-------	---------

Tensão	100-240V
Potência total	12W
Fluxo luminoso total	900lm
Especificações	60 LEDs SMD2835/m
IRC	>80
Vida útil	25.000h
Grau de proteção	IP20

Fonte inclusa.

Permite corte a cada 5cm.



Produto Stella: Fita ECO 12V | Arquiteta: Cristina da Luz
Mostra Glass Home 2018 | Foto: Rêpôis Imagens

FITA 24V

Alto Índice de Reprodução de Cor

Luz homogênea devido à quantidade de LEDs por metro

Diversas temperaturas de cor, opção RGBW

Permite controle da intensidade da luz com fonte dimerizável

Utilizar somente com fonte 24Vcc Stella, adquirida separadamente.



Produto Stella: Fita EVO 24V

4,5W/m

360 lumens/m

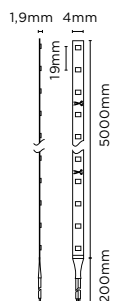

FITA MINI 24V

ROLO 5m

PRODUTO PRO



Super discreta!
Espessura fina, indicada para aplicação em móveis.

STH8840/27 - 24Vcc - IP20 | 2700K | 360lm/m

Tensão	24Vcc ¹
Potência total	22,5W
Fluxo luminoso total	1800lm
Especificações	56 LEDs SMD2014/m
IRC	>90
Vida útil (L70)	25.000h

¹ Fontes indicadas: págs. 78 e 79.
Acessórios indicados: conector e emenda para Fita Mini (pág. 77).
Permite corte a cada 12,5cm.

16W/m

1100 lumens/m

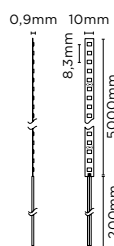

FITA EVO FULL LED 24V

ROLO 5m

PRODUTO PRO



STH6826/27 - 24Vcc - IP20 | 2700K | 1100lm/m

Tensão	24Vcc ²
Potência total	80W
Fluxo luminoso total	5500lm
Especificações	120 LEDs SMD2216/m
IRC	>90
Vida útil (L70)	25.000h

² Fontes indicadas: págs. 78 e 79.
Acessórios indicados: conector e emenda para Fita 10mm (pág. 77).
Permite corte a cada 5cm.

19W/m

2600 lumens/m

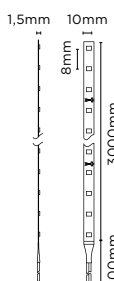

FITA EVO FULL LED 24V

ROLO 3m

PRODUTO PRO



STH8835/27 - 24Vcc - IP20 | 2700K | 2600lm/m

Tensão	24Vcc ³
Potência total	57W
Fluxo luminoso total	7800lm
Especificações	192 LEDs SMD2835/m
IRC	>80
Vida útil (L70)	25.000h

³ Fontes indicadas: págs. 78 e 79. Não indicamos o uso de mais de 3m de fita por fonte.
Acessórios indicados: conector e emenda para Fita 10mm (pág. 77).
Permite corte a cada 4,15cm.

12W/m
600 lumens/m

FITA EVO RGBW 24V

ROLO 5m

PRODUTO PRO

LUZ RGBW

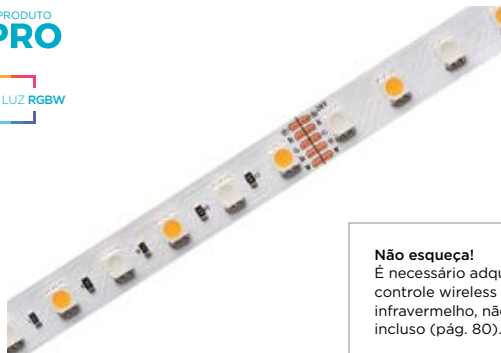
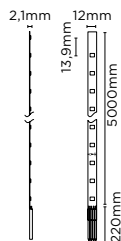

Não esqueça!
É necessário adquirir controle wireless ou infravermelho, não incluso (pág. 80).

STH6830/RGBW - 24Vcc - IP20	RGB/2700K
-----------------------------	-----------

Tensão	24Vcc ¹
Potência total	60W
Especificações	72 LEDs SMD5050/m
IRC 2700K	>80
Vida útil (L70)	25.000h

A tecnologia RGBW corresponde às seguintes variações de cor: R (red) - vermelho, G (green) - verde, B (blue) - azul e W (white) - branco.

¹ Fontes indicadas: págs. 78 e 79.

Accessórios indicados: conector, emenda, controle a amplificador para Fitas RGBW (pág. 77).
Permite corte a cada 16,55cm.

Utilize um amplificador e uma fonte adicional a cada 5m.

Não ultrapasse o limite de potência da fonte.
Diagrama de instalação disponível na pág. 82.

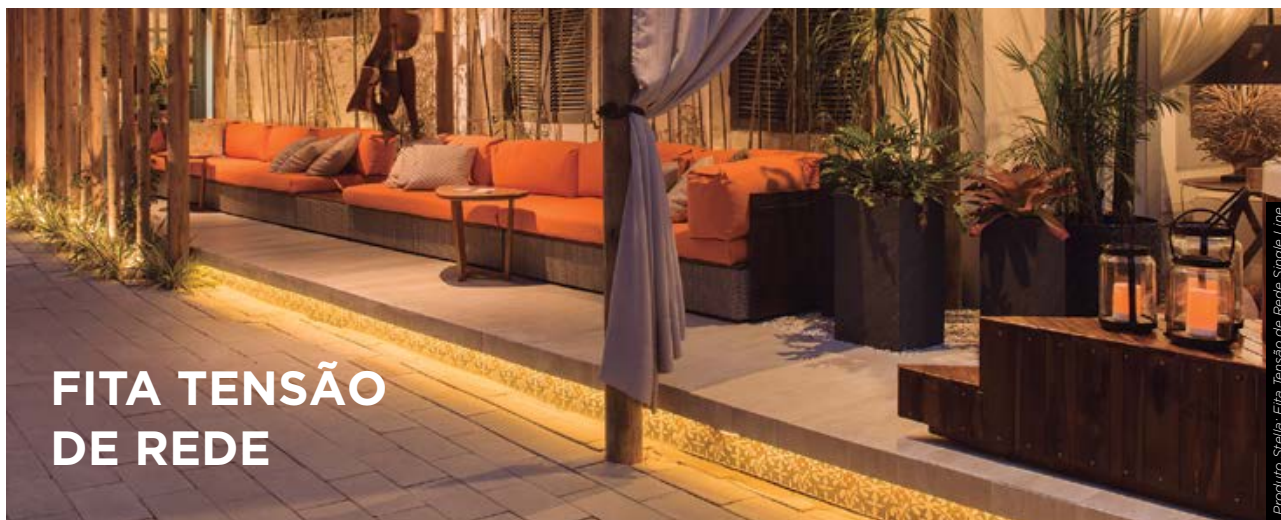

FITA TENSÃO DE REDE

5W/m
200 lumens/m

FITA TENSÃO DE REDE SINGLE LINE

ROLO 25m



STH7821/30 - 127V - IP67	3000K	200lm/m
STH7822/30 - 220V - IP67	3000K	200lm/m
STH7821/57 - 127V - IP67	5700K	200lm/m
STH7822/57 - 220V - IP67	5700K	200lm/m

Tensão	127V ou 220V
Potência total	125W
Fluxo luminoso total	5000lm
Especificações	60 LEDs SMD2835/m
IRC	>70
Vida útil (L70)	25.000h

A embalagem contém um rolo de fita de 25m, um alimentador, duas emendas e dois terminais.

Accessórios indicados: kit de ligação, braçadeiras e emenda (págs. 80 e 81).

Permite corte a cada 50cm (127V) e 100cm (220V).

10W/m
550 lumens/m

FITA TENSÃO DE REDE DOUBLE LINE

ROLO 25m

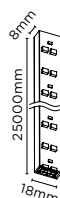

STH7831/30 - 127V - IP67	3000K	550lm/m
STH7832/30 - 220V - IP67	3000K	550lm/m

Tensão	127V ou 220V
Potência total	250W
Fluxo luminoso total	13750lm
Especificações	120 LEDs SMD2835/m
IRC	>70
Vida útil (L70)	25.000h

A embalagem contém um rolo de fita de 25m, um alimentador, duas emendas e dois terminais.

Accessórios indicados: kit de ligação, braçadeiras e emenda (págs. 80 e 81).

Permite corte a cada 50cm (127V) e 100cm (220V).

**5W/m**

200 lumens/m

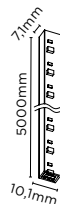

KIT FITA TENSÃO DE REDE SINGLE LINE

ROLO 5m



STH7801/30 - 127V - IP67	3000K	200lm/m
STH7802/30 - 220V - IP67	3000K	200lm/m
STH7801/57 - 127V - IP67	5700K	200lm/m
STH7802/57 - 220V - IP67	5700K	200lm/m

Tensão	127V ou 220V
Potência total	25W
Fluxo luminoso total	1000lm
Especificações	60 LEDs SMD2835/m
IRC	>70
Vida útil (L70)	25.000h

A embalagem contém um rolo de fita de 5m, um alimentador, uma emenda, um terminal e 10 braçadeiras. Permite corte a cada 50cm (127V) e 100cm (220V).

10W/m

550 lumens/m



KIT FITA TENSÃO DE REDE DOUBLE LINE

ROLO 5m



STH7811/30 - 127V - IP67	3000K	550lm/m
STH7812/30 - 220V - IP67	3000K	550lm/m
STH7811/57 - 127V - IP67	5700K	550lm/m
STH7812/57 - 220V - IP67	5700K	550lm/m

Tensão	127V ou 220V
Potência total	50W
Fluxo luminoso total	2750lm
Especificações	120 LEDs SMD2835/m
IRC	>70
Vida útil (L70)	25.000h

A embalagem contém um rolo de fita de 5m, um alimentador, uma emenda, um terminal e 10 braçadeiras. Permite corte a cada 50cm (127V) e 100cm (220V).

TENSÃO DE REDE: FITA NEON

7W/m

200 lumens/m

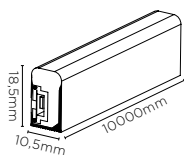

FITA LED TENSÃO DE REDE NEON

ROLO 10m



STH7861/27 - 127V - IP65	2700K	200lm/m
STH7862/27 - 220V - IP65		
STH7861/60 - 127V - IP65	6000K	200lm/m
STH7862/60 - 220V - IP65		
STH7861/AZ - 127V - IP65	LUZ AZUL	
STH7862/AZ - 220V - IP65		
STH7861/VM ¹ - 127V - IP65	LUZ VERMELHA	
STH7862/VM ¹ - 220V - IP65		

Tensão	127V ou 220V
Potência total	70W
Fluxo luminoso total 2700K e 6000K	2000lm
Especificações	108 LEDs SMD2835/m
Vida útil (L70)	25.000h

¹ Produto disponível apenas enquanto durarem os estoques. A embalagem contém um rolo de fita de 10m, um alimentador, uma emenda, um terminal e 20 braçadeiras. Acessórios indicados: kit de ligação, braçadeiras e emenda (pág. 81). Permite corte a cada 50cm (127V) e 100cm (220V).



Produtos Stella: Fita LED Tensão De Rede, Neon e Arandela Effect | Arquiteta: Renata Marques | Mostra Glass Home 2018 | Foto: RPB018 Imagens



Produto Stella, Fita EVO 12V

ACESSÓRIOS E FONTES

ACESSÓRIOS E FONTES PARA FITA 12V

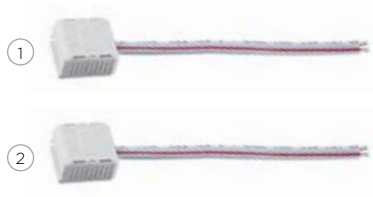

CONECTORES PARA FITAS 12V

①	STH6871	Conector 2 fios para Fita 8mm
②	STH6873	Conector 2 fios para Fita 10mm



EMENDAS PARA FITAS 12V

①	STH6872	Emenda para Fita 8mm
②	STH6874	Emenda para Fita 10mm

15W

FONTE 12V PARA FITAS

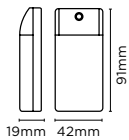

STH6890 - BIVOLT

Tensão de entrada	100-240V
Tensão de saída	12Vcc
Corrente de saída	1.25A
Proteção	IP20

25W

FONTE 12V PARA FITAS

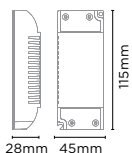

STH8891 - BIVOLT

Tensão de entrada	100-240V
Tensão de saída	12Vcc
Corrente de saída	2.08A
Proteção	IP20

**36W**

LANÇAMENTO

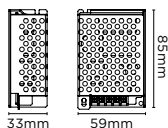
**FONTA ECO 12V
PARA FITAS****STH9892 - BIVOLT**

Tensão de entrada	100-240V
Tensão de saída	12Vcc
Corrente de saída	3A

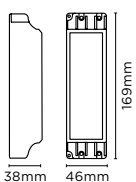
40W**FONTA 12V
PARA FITAS****STH6892 - BIVOLT**

Tensão de entrada	100-240V
Tensão de saída	12Vcc
Corrente de saída	3.34A
Grau de proteção	IP20

60W

LANÇAMENTO

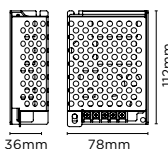
**FONTA ECO 12V
PARA FITAS****STH9893 - BIVOLT**

Tensão de entrada	100-240V
Tensão de saída	12Vcc
Corrente de saída	5A

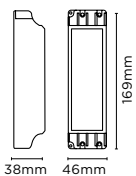
75W**FONTA 12V
PARA FITAS****STH6893 - BIVOLT**

Tensão de entrada	100-240V
Tensão de saída	12Vcc
Corrente de saída	6.25A
Grau de proteção	IP20

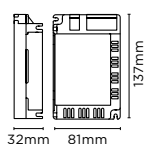
40W**FONTA 12V
DIMERIZÁVEL
PARA FITAS****STH5899 - BIVOLT**

Tensão de entrada	127V/220V ¹
Tensão de saída	12Vcc
Corrente de saída	3.3A

¹ A tensão de entrada deve ser ajustada na chave seletora, conforme indicação impressa no produto. Diagrama de instalação disponível na pág. 82.

75W

FONTE 12V
DIMERIZÁVEL
 PARA FITAS

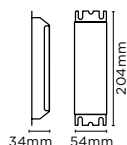

STH4871 - 127V
STH4872 - 220V

Tensão de entrada	127V ou 220V
Tensão de saída	12Vcc
Corrente de saída	6.2A

Diagrama de instalação disponível na pág. 82.

INDICAÇÃO DE USO DE FONTES PARA FITAS 12V

FITAS 12V POTÊNCIA/ REFERÊNCIA	FONTES PARA FITAS						FONTES DIMERIZÁVEIS PARA FITAS	
	STH6890 15W	STH8891 25W	STH9892 36W	STH6892 40W	STH9893 60W	STH6893 75W	STH5899 40W Dimerizável	STH4871 / STH4872 75W Dimerizável
5W/m STH7804/XX STH7805/XX	Até 3m	Até 5m	Até 5m	-	-	-	Até 5m	-
6W/m STH6800/XX STH6805/XX STH7800/XX	Até 2,5m	Até 4,1m	Até 5m	Até 5m	-	-	Até 5m	-
10W/m STH7814/XX STH7815/XX	Até 1,5m	Até 2,5m	Até 3,6m	Até 4m	Até 5m	Até 5m	Até 4m	Até 5m
12W/m STH6810/XX STH6815/XX	Até 1,2m	Até 2m	Até 3,6m	Até 3,3m	Até 5m	Até 5m	Até 3,3m	Até 5m

Não recomendamos a utilização de mais de 5m de Fita 12V ligados em série, a fim de evitar perdas no fluxo luminoso.

ACESSÓRIOS E FONTES PARA FITA 24V

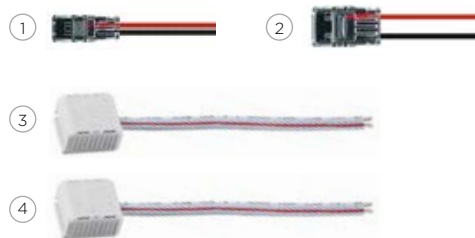

CONECTORES PARA FITAS 24V

①	STH8871	Conector 2 fios para Fita Mini
②	STH8873	Conector 2 fios para Fita Full LED
③	STH6871	Conector 2 fios para Fita 8mm
④	STH6873	Conector 2 fios para Fita 10mm



EMENDAS PARA FITAS 24V

①	STH8872	Emenda para Fita Mini
②	STH8874	Emenda para Fita Full LED
③	STH6872	Emenda para Fita 8mm
④	STH6874	Emenda para Fita 10mm



15W

**FONTE 24V
 PARA FITAS**

STH6894 - BIVOLT

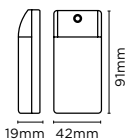

Tensão de entrada	100-240V
Tensão de saída	24Vcc
Corrente de saída	0,62A
Grau de proteção	IP20

25W

**FONTE 24V
 PARA FITAS**

STH8895 - BIVOLT

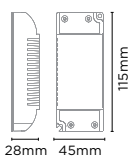

Tensão de entrada	100-240V
Tensão de saída	24Vcc
Corrente de saída	1,04A
Grau de proteção	IP20

60W

**FONTE 24V
 PARA FITAS**

STH6896 - BIVOLT

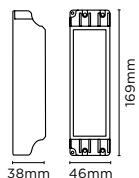

Tensão de entrada	100-240V
Tensão de saída	24Vcc
Corrente de saída	2,50A
Grau de proteção	IP20

100W

**FONTE 24V
 PARA FITAS**

STH6897 - BIVOLT

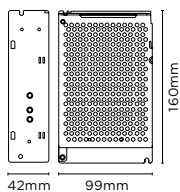

Tensão de entrada	100-240V
Tensão de saída	24Vcc
Corrente de saída	4,17A

40W

**FONTE 24V
 DIMERIZÁVEL
 PARA FITAS**

STH8899 - BIVOLT

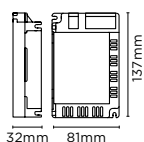

Tensão de entrada	127V/220V
Tensão de saída	24Vcc
Corrente de saída	1,6A

100W

FONTE 24V

DIMERIZÁVEL

PARA FITAS

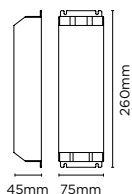

STH9881 - 127V

STH9882 - 220V

Tensão de entrada	127V ou 220V
Tensão de saída	24Vcc
Corrente de saída	4,16A

INDICAÇÃO DE USO DE FONTES PARA FITAS 24V

FITAS 24V POTÊNCIA/ REFERÊNCIA	FONTES PARA FITAS				FONTES DIMERIZÁVEIS PARA FITAS	
	STH6894 15W	STH8895 25W	STH6896 60W	STH6897 100W	STH8899 40W Dimerizável	STH9881 / STH9882 100W Dimerizável
FITA MINI 24V 4,5W/m STH8840/27	Até 3m	Até 5m	-	-	Até 2m	Até 5m
FULL LED 16W/m STH6826/27	-	Até 1,55m	Até 3,75m	Até 5m	Até 2,5m	Até 5m
FULL LED 19W/m STH8835/27	-	Até 1m	Até 3m	Até 3m	Até 2m	Até 3m
RGBW 12W/m STH6830/RGBW	Até 1,2m	Até 2m	Até 5m	-	Até 3m	Até 5m

Não recomendamos a utilização de mais de 5m de Fita 24V ligados em série, a fim de evitar perdas no fluxo luminoso - exceto no caso da Fita FULL LED 19W/m.

ACESSÓRIOS PARA FITA RGBW



CONECTOR

PARA FITAS RGBW

① **STH6875** | Conector 5 fios para Fita RGBW



EMENDA

PARA FITAS RGBW

① **STH6876** | Emenda para Fita RGBW

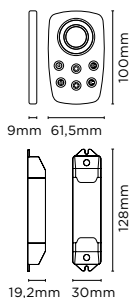

CONTROLE WIRELESS PARA FITAS RGBW

STH6880

Tensão 12Vcc/24Vcc

Controle wireless com alcance de até 20m.
Possibilita trocar as cores manualmente ou pelos modos automáticos e aumentar e diminuir a intensidade de luz.
Incluso receptor.

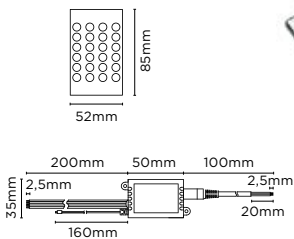

CONTROLE INFRAVERMELHO PARA FITAS RGBW

STH6885

Tensão 12Vcc/24Vcc

Possibilita trocar as cores manualmente ou pelos modos automáticos e aumentar e diminuir a intensidade de luz.
Incluso receptor.

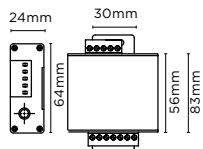

AMPLIFICADOR PARA FITAS RGBW

STH6889

Tensão 12Vcc/24Vcc

Corrente de saída total 2A por canal / 8A total

Amplifica o sinal RGBW, possibilitando a utilização em circuitos superiores a 5m (indicação de uso de um amplificador e uma fonte a cada 5m de Fita RGBW). Mantém a qualidade do sinal e a tensão contínua de 24V em todo o sistema.

ACESSÓRIOS PARA FITA TENSÃO DE REDE



KIT DE LIGAÇÃO

PARA FITAS TENSÃO DE REDE

STH7803 | 5W/m Single Line

STH7813 | 10W/m Double Line

Tensão: 127V/220V.

Atenção: não ligar mais do que 50m de fita por alimentador.
A embalagem contém um alimentador e um terminal.



BRAÇADEIRAS

PARA FITAS TENSÃO DE REDE

1 STH7898 | 5W/m Single Line

2 STH7899 | 10W/m Double Line

A embalagem contém 50 braçadeiras.



EMENDAS

PARA FITAS TENSÃO DE REDE

①	STH7876	Emenda para Fita Tensão de Rede 5W/m Single Line
②	STH7877	Emenda para Fita Tensão de Rede 10W/m Double Line

ACESSÓRIOS PARA FITA LED TENSÃO DE REDE NEON



KIT DE LIGAÇÃO

PARA FITAS LED TENSÃO DE REDE NEON

STH7869

Tensão: 127V/220V.

A embalagem contém um alimentador e um terminal.



BRAÇADEIRAS

PARA FITAS LED TENSÃO DE REDE NEON

STH7868

A embalagem contém 10 braçadeiras.



EMENDAS

PARA FITAS LED TENSÃO DE REDE NEON

STH8875	Emenda para Fita Tensão de Rede Neon
----------------	--------------------------------------

A embalagem contém 50 emendas.

DIAGRAMA DE INSTALAÇÃO PARA FONTES DIMERIZÁVEIS 12V OU 24V



DIAGRAMA DE INSTALAÇÃO PARA FITA RGBW 24V



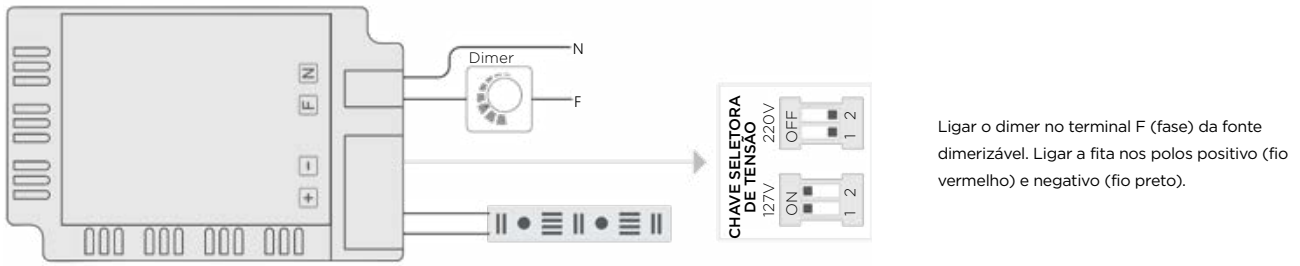
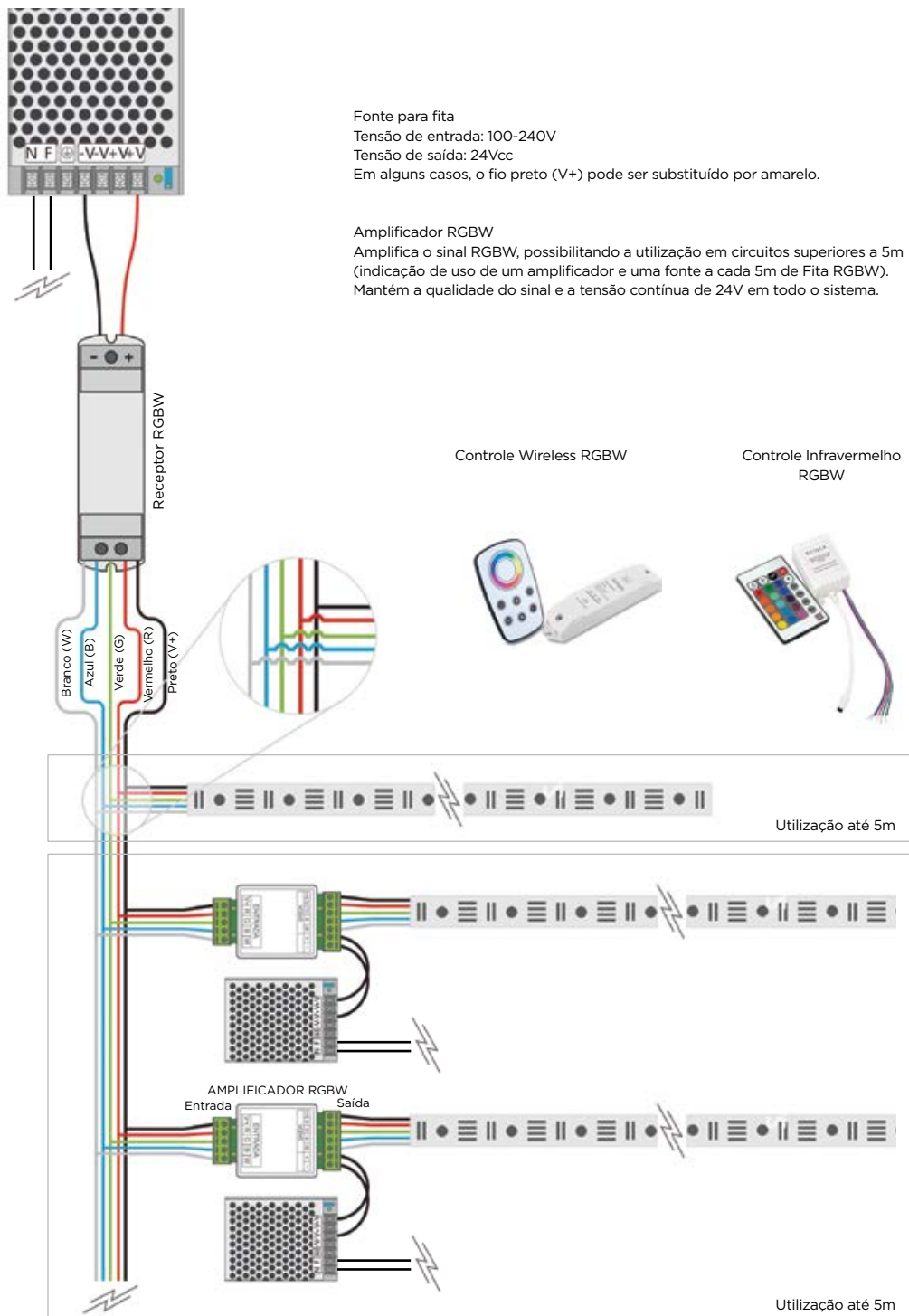
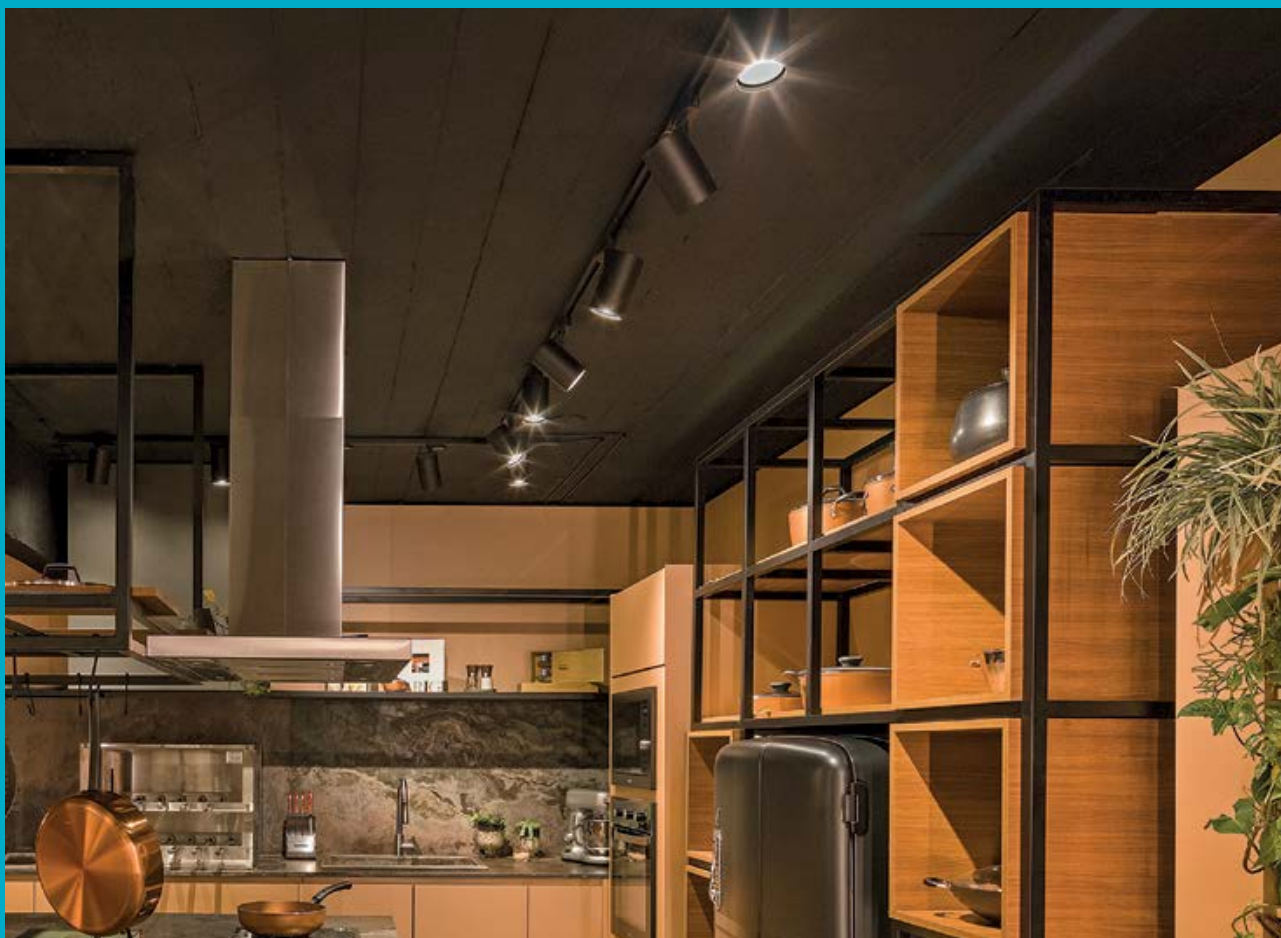

Produtos Stella: Trilho de Sobrepор, Spot Zylinder e lâmpada PAR20 | Arquiteta: Adriana Klaus | Mostra EliteDesign 2018 | Foto: RPDOIS Imagens

TRILHOS

- 84 TRILHO DE EMBUTIR
TRILHO DE SOBREPOR
- 85 ACESSÓRIOS PARA TRILHO
- 86 SPOT FLOW
- 89 SPOT CÊNICO
SPOT ZYLINDER
- 91 SPOT VOLL
- 92 SPOT

Os gráficos luminotécnicos de todos os produtos estão disponíveis no capítulo Gráficos deste catálogo e no site stella.com.br, onde também consta o tempo de garantia de cada produto.





TRILHO

Para embutir ou sobrepôr

Compatível com todos os spots Stella

Perfeito para distribuir pontos de iluminação no ambiente

Adequado para todo tipo de forro

Os trilhos Stella podem ser cortados e emendados para que se adaptem aos mais diversos projetos. Para isso, utilize os acessórios Stella adequados.



Produtos Stella: Trilho de Embutir, Spot, Zylinder e lâmpada Dicroica | Arquiteto: Ildo Silva | Mostra Glass Home 2018 | Foto: RPDOIS Imagens



TRILHO DE EMBUTIR

SD1910BR	BRANCO	1m
SD1910PTO	PRETO	1m
SD1915BR	BRANCO	1,5m
SD1915PTO	PRETO	1,5m
SD1920BR	BRANCO	2m
SD1920PTO	PRETO	2m

Material predominante: alumínio. Inklusos alimentador e ponteira.

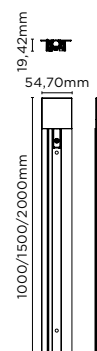

TRILHO DE SOBREPÔR

SD1010BR	BRANCO	1m
SD1010PTO	PRETO	1m
SD1010ST	SATIN SILVER	1m
SD1015BR	BRANCO	1,5m
SD1015PTO	PRETO	1,5m
SD1015ST	SATIN SILVER	1,5m
SD1020BR	BRANCO	2m
SD1020PTO	PRETO	2m
SD1020ST	SATIN SILVER	2m

Material predominante: alumínio. Inklusos alimentador e ponteira.

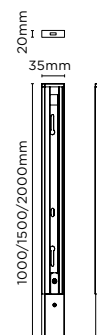

ACESSÓRIOS PARA TRILHO DE EMBUTIR



CONEXÃO I

SD1205BR	BRANCO
SD1205PTO	PRETO



PONTEIRA

SD1209BR	BRANCO
SD1209PTO	PRETO



CONEXÃO L

SD1206BR	BRANCO
SD1206PTO	PRETO



ALIMENTADOR

SD1208BR	BRANCO
SD1208PTO	PRETO



CONEXÃO T

SD1207BR	BRANCO
SD1207PTO	PRETO

ACESSÓRIOS PARA TRILHO DE SOBREPOR



CONEXÃO I

SD1043BR	BRANCO
SD1043PTO	PRETO
SD1043ST	SATIN SILVER



PONTEIRA

SD1047BR	BRANCO
SD1047PTO	PRETO
SD1047ST	SATIN SILVER



CONEXÃO L

SD1044BR	BRANCO
SD1044PTO	PRETO
SD1044ST	SATIN SILVER



ALIMENTADOR

SD1046BR	BRANCO
SD1046PTO	PRETO
SD1046ST	SATIN SILVER



CONEXÃO T

SD1045BR	BRANCO
SD1045PTO	PRETO
SD1045ST	SATIN SILVER

ACESSÓRIOS PARA TRILHO DE EMBUTIR E DE SOBREPOR

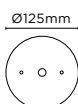

CANOPLA PLANA PARA TRILHO

SD1000BR	BRANCO
SD1000PTO	PRETO

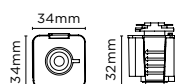

ADAPTADOR

SD1100BR	BRANCO
SD1100PTO	PRETO
SD1100ST	SATIN SILVER



FLOW. LUZ QUE FLUI.

Recuo ampliado da fonte luminosa.
 Possibilidade de maior controle da luz com o uso
 de grade antiofuscante. Robusto e moderno.
 Design próprio e exclusivo Stella.

FLOW PAR30 - SD1960BR | KIT GRADE PAR30 - SD1906



SPOT FLOW MR11

LANÇAMENTO

SD1930BR	BRANCO
SD1930PTO	PRETO

Lâmpada indicada: MR11 GU10.
Potência máxima: 15W.
Material: alumínio e ABS.
PATENTE REQUERIDA

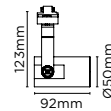

SPOT FLOW MR16

LANÇAMENTO

SD1940BR	BRANCO
SD1940PTO	PRETO

Lâmpada indicada: MR16 GU10.
Potência máxima: 15W.
Material: alumínio e ABS.
PATENTE REQUERIDA

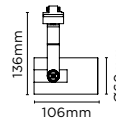

SPOT FLOW PAR20

LANÇAMENTO

SD1950BR	BRANCO
SD1950PTO	PRETO

Lâmpada indicada: PAR20.
Potência máxima: 15W.
Material: alumínio e ABS.
PATENTE REQUERIDA

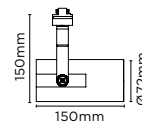

SPOT FLOW PAR30

LANÇAMENTO

SD1960BR	BRANCO
SD1960PTO	PRETO

Lâmpada indicada: PAR30.
Potência máxima: 15W.
Material: alumínio e ABS.
PATENTE REQUERIDA

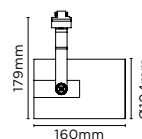



SPOT FLOW AR70

LANÇAMENTO

SD1970BR	BRANCO
SD1970PTO	PRETO

Lâmpada indicada: AR70 GU10.
Potência máxima: 15W.
Material: alumínio e ABS.
PATENTE REQUERIDA

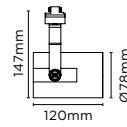

SPOT FLOW AR111

LANÇAMENTO

SD1980BR	BRANCO
SD1980PTO	PRETO

Lâmpada indicada: AR111 GU10.
Potência máxima: 15W.
Material: alumínio e ABS.
PATENTE REQUERIDA

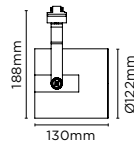

GRADE ANTIOFUSCANTE
PARA MAIOR CONTROLE DA LUZ

FLOW PAR30 - SD1960PTO | KIT GRADE PAR30 - SD1906

KIT GRADE PARA SPOT FLOW

LANÇAMENTO

SD1903	MR11
SD1904	MR16
SD1905	PAR20
SD1906	PAR30
SD1907	AR70
SD1908	AR111

Material: alumínio e ABS.
PATENTE REQUERIDA



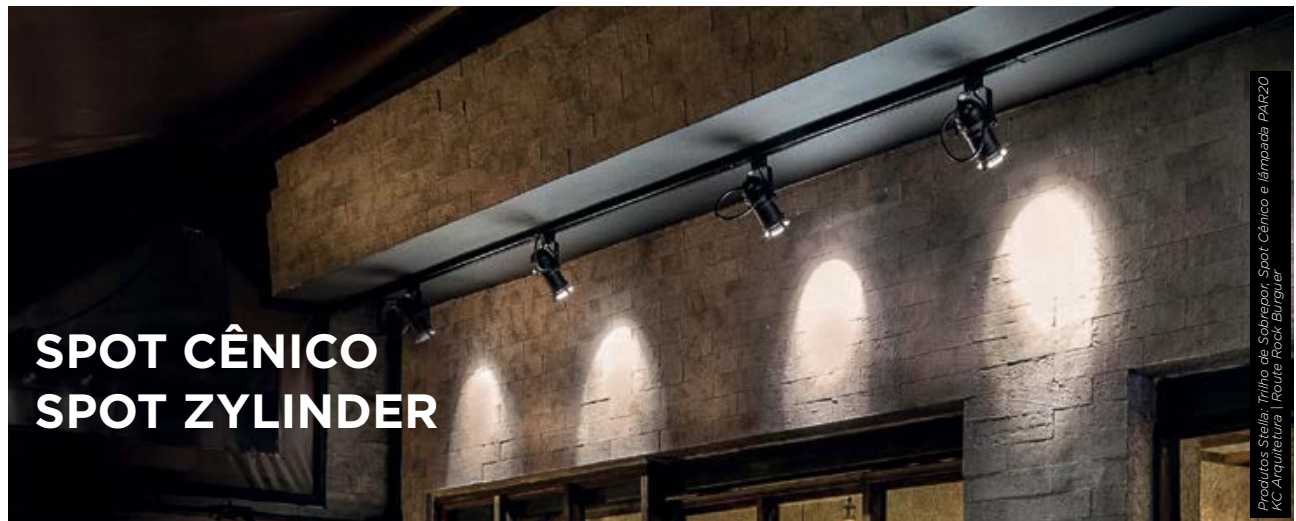

Produtos Stella, Trilho de Sobressol, Spot Cênico e Lâmpada PAR20
KC Arquitetura | Route, Rock Bugliar

SPOT CÊNICO SPOT ZYLINDER



FILTROS COLORIDOS

VERMELHO+VERDE+AZUL+AMARELO

Os Spots Cênicos vêm com um kit composto por 04 filtros para construção de efeitos coloridos.

SPOT CÊNICO MR16

SD1655PTO	PRETO	Spot com adaptador para trilho
SD1650PTO	PRETO	Spot com canopla



SD1655PTO

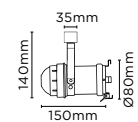

SD1650PTO

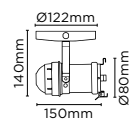

Lâmpada indicada: 1 X MR16 GU10.
Potência máxima: 35W.
Material predominante: aço.



FILTROS COLORIDOS

VERMELHO+VERDE+AZUL+AMARELO

Os Spots Cênicos vêm com um kit composto por 04 filtros para construção de efeitos coloridos.

SPOT CÊNICO PAR20/PAR30

SD1675PTO	PRETO	Spot com adaptador para trilho
SD1670PTO	PRETO	Spot com canopla



SD1675PTO

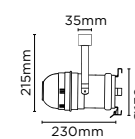

SD1670PTO

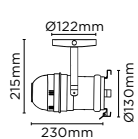

Lâmpada indicada: 1 X PAR20 ou 1 X PAR30.
Potência máxima: 75W.
Material predominante: aço.



SPOT ZYLINDER MR16

SD1710BR	BRANCO
SD1710PTO	PRETO

Lâmpada indicada: 1 X MR16 GU10.
Potência máxima: 35W.
Material: alumínio.

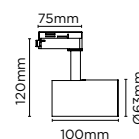



SPOT ZYLINDER PAR20

SD1720BR	BRANCO
SD1720PTO	PRETO

Lâmpada indicada: 1 X PAR20.
Potência máxima: 35W.
Material: alumínio.

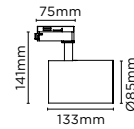

SPOT ZYLINDER PAR30

SD1730BR	BRANCO
SD1730PTO	PRETO

Lâmpada indicada: 1 X PAR30.
Potência máxima: 35W.
Material: alumínio.

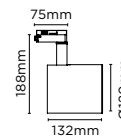

SPOT ZYLINDER AR70

SD1740BR	BRANCO
SD1740PTO	PRETO

Lâmpada indicada: 1 X AR70 GU10.
Potência máxima: 35W.
Material: alumínio.

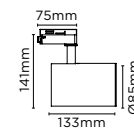

SPOT ZYLINDER AR111

SD1750BR	BRANCO
SD1750PTO	PRETO

Lâmpada indicada: 1 X AR111 GU10.
Potência máxima: 35W.
Material: alumínio.

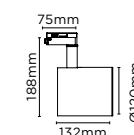



SPOT VOLL

LED integrado
Diversas potências
Fácil de instalar

Produtos Stella - Trilho de Sobrepor e Spot Voll
Arquiteto: Ney Filho | CASACOR CE 2018

4W
350 lumens

SPOT VOLL LED INTEGRADO

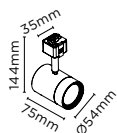

SD1800BR/30 - BRANCO - BIVOLT	3000K	350lm
SD1800PTO/30 - PRETO - BIVOLT	3000K	350lm

Tensão	100-240V
Intensidade luminosa	700cd
Eficiência luminosa	88lm/W
Ângulo de abertura	34°
IRC	>80
Vida útil (L70)	20.000h
Material	Policarbonato

7W
550 lumens

SPOT VOLL LED INTEGRADO

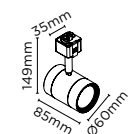

SD1805BR/30 - BRANCO - BIVOLT	3000K	550lm
SD1805PTO/30 - PRETO - BIVOLT	3000K	550lm

Tensão	100-240V
Intensidade luminosa	1335cd
Eficiência luminosa	79lm/W
Ângulo de abertura	38°
IRC	>80
Vida útil (L70)	25.000h
Material	Policarbonato

14W
1300 lumens

SPOT VOLL LED INTEGRADO

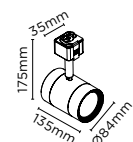

SD1810BR/30 - BRANCO - BIVOLT	3000K	1300lm
SD1810PTO/30 - PRETO - BIVOLT	3000K	1300lm

Tensão	100-240V
Intensidade luminosa	2860cd
Eficiência luminosa	93lm/W
Ângulo de abertura	38°
IRC	>80
Vida útil (L70)	25.000h
Material	Policarbonato



SPOT

Versátil e tradicional
Modelos em branco,
preto e satin silver
Opções com canopla

Produtos Stella: Trilho de Sobrepiso Spot Rio e lâmpada AR70_24°
Arquiteto: Lucas Prates | Mostra EliteDesign_2018 | Foto: RPD015 Imagens



SPOT MR16

SD1050BR	BRANCO
SD1050PTO	PRETO
SD1050ST	SATIN SILVER

Lâmpada indicada: 1 X MR16 GU10.
Potência máxima: 50W.
Material: alumínio.

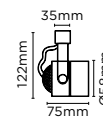

SPOT PAR20

SD1070BR	BRANCO
SD1070PTO	PRETO
SD1070ST	SATIN SILVER

Lâmpada indicada: 1 X PAR20.
Potência máxima: 50W.
Material: alumínio.

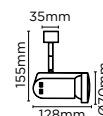

SPOT PAR30

SD1080BR	BRANCO
SD1080PTO	PRETO
SD1080ST	SATIN SILVER

Lâmpada indicada: 1 X PAR30.
Potência máxima: 50W.
Material: alumínio.

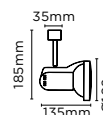



SPOT AR70

SD1170BR	BRANCO
SD1170PTO	PRETO
SD1170ST	SATIN SILVER

Lâmpada indicada: 1 X AR70 GU10.
Potência máxima: 50W.
Material: alumínio.

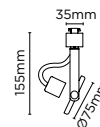

SPOT AR111

SD1060BR	BRANCO
SD1060PTO	PRETO

Lâmpada indicada: 1 X AR111 GU10.
Potência máxima: 50W.
Material: alumínio.

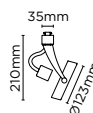

SPOT MR16 COM CANOPLA

SD1550BR	BRANCO
SD1550PTO	PRETO

Lâmpada indicada: 1 X MR16 GU10.
Potência máxima: 50W.
Material: alumínio.

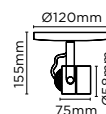

SPOT PAR20 COM CANOPLA

SD1570BR	BRANCO
SD1570PTO	PRETO

Lâmpada indicada: 1 X PAR20.
Potência máxima: 50W.
Material: alumínio.

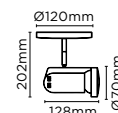



SPOT PAR30 COM CANOPLA

SD1580BR	BRANCO
SD1580PTO	PRETO

Lâmpada indicada: 1 X PAR30.
Potência máxima: 75W.
Material: alumínio.

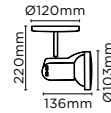

SPOT AR111 COM CANOPLA

SD1560BR	BRANCO
SD1560PTO	PRETO

Lâmpada indicada: 1 X AR111 GU10.
Potência máxima: 50W.
Material: alumínio.

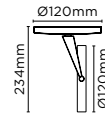

Produtos Stella: Trilho de Sobrepôr, Spot, Zylinder e lâmpada AR70 | Arquitetos: Humberto Zirpoli e Alice Zirpoli | CASACOR PE 2018



Produtos Stella: Pendente Cionero e Pendente Suka | Foto: RPDOIS Imagens

DECORATIVA

- 96 LINHA KRAFT
- 98 PENDENTES
- 103 LUMINÁRIAS EM CONCRETO
- 107 LUMINÁRIAS MODERNAS
- 113 LINHA CRISTAL

O tempo de garantia de cada produto está disponível no site stella.com.br.





PENDENTE KRAFT

LANÇAMENTO

Lâmpada indicada: 1 X E27 Filamento Stella.
Material: kraft.

SD8430	PRISMA	1	SD8435	ELIPSE Ø35cm	6
SD8431	TRAPÉZIO	2	SD8436	PLANETÁRIO	7
SD8432	ESFERA Ø30cm	3	SD8437	COLMEIA Ø25cm	8
SD8433	ESFERA Ø40cm	4	SD8438	COLMEIA Ø35cm	9
SD8434	ELIPSE Ø25cm	5	SD8439	CONE	10

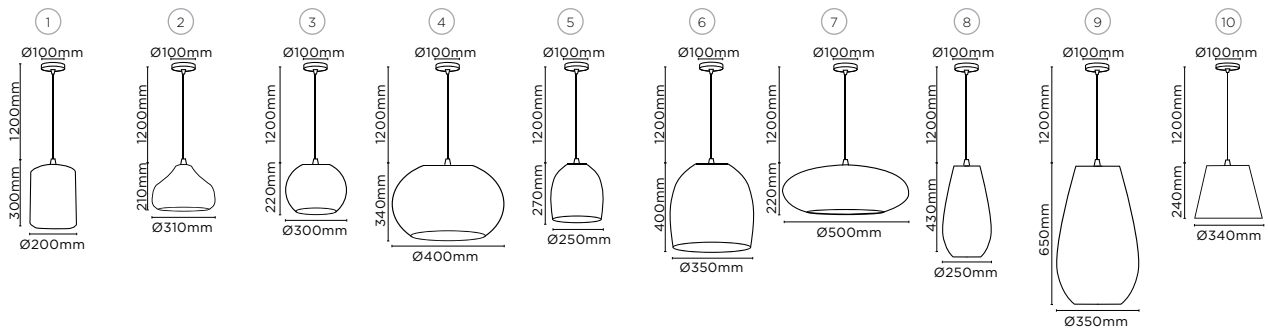



Produto Stella: Coluna Kraft | Arquiteta: Cristina da Luz | Mostra Glass Home 2018 | Foto: RPDOS Imagens



COLUNA KRAFT

LANÇAMENTO

Lâmpada indicada: 1 X E27 Filamento Stella.
Material predominante: kraft.

SD6230

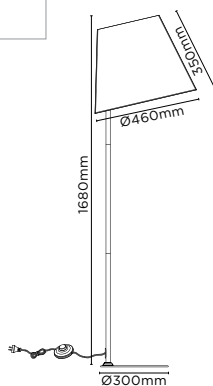

LUMINÁRIA DE MESA KRAFT

LANÇAMENTO

Lâmpada indicada: 1 X E27 Filamento Stella.
Material predominante: kraft.

SD6330

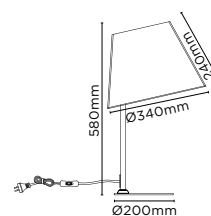



PENDENTE HAVANA Ø22cm

LANÇAMENTO

Lâmpada indicada: 1 X E27 Filamento Stella.
Material: metal.

SD8932	COBRE
SD8933	PRETO

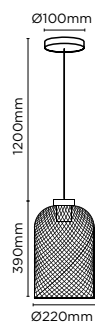

PENDENTE HAVANA Ø30cm

LANÇAMENTO

Lâmpada indicada: 1 X E27 Filamento Stella.
Material: metal.

SD8934	COBRE
SD8935	PRETO

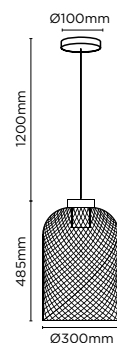



PENDENTE RETRONIC

Lâmpada indicada: 1 X E27 Filamento Stella.
Material: metal e madeira.

SD8053	BRANCO
SD8050	PRETO
SD8055	BRANCO
SD8056	PRETO

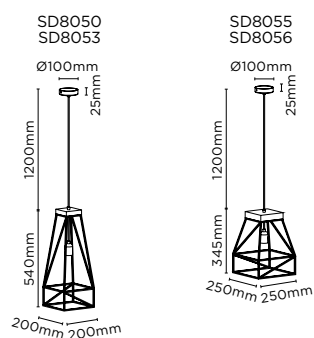

PENDENTE NÓTUS

Lâmpada indicada: 1 X E27 Bulbo.
Material: madeira.

SD8020	BRANCO
SD8025	PRETO
SD8030	BRANCO
SD8035	PRETO
SD8040	BRANCO
SD8045	PRETO

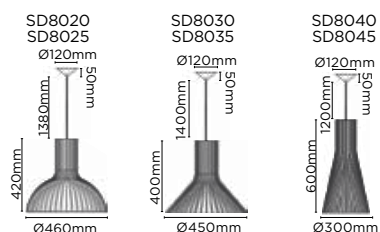



PENDENTE DAKINI

Lâmpada indicada: 1 X E27 Bulbo.
Material: metal.

SD8530	SD8540	SD8550



PENDENTE

Lâmpada indicada: 1 X G9.
Material: metal.

SD8512	SD8522



PENDENTE

Lâmpada indicada: 1 X E27 Mini Bulbo Filamento Stella.
Material: metal.

SD8501	CROMADO
SD8502	PRETO
SD8503	BRANCO

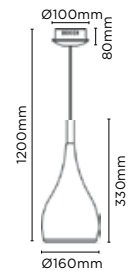

PENDENTE ESFERA DE VIDRO

Lâmpada indicada: 1 X E27 Filamento Stella.
Material predominante: vidro.

CROMADO			
SD8125	SD8130	SD8135	SD8140
COBRE			
SD8230	SD8235	SD8240	

Por tratar-se de um processo manual de produção, é possível encontrar algumas variações no vidro.



PENDENTES YARA, INDRA E SHIVA

Lâmpada indicada: 1 X E27 Filamento Stella.
Material: aço carbono.

SD8403 - YARA

SD8404 - INDRA

SD8405 - SHIVA

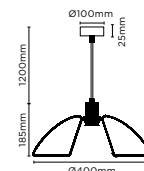
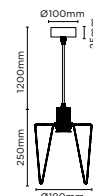
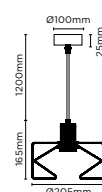

PENDENTE DANU

Lâmpada indicada: 1 X E27 Filamento Stella.
Material: alumínio e madeira.

SD8406

BRANCO FOSCO

SD8407

PRETO FOSCO

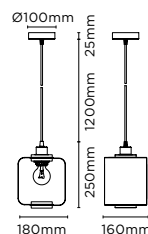

PENDENTE HERA

Lâmpada indicada: 1 X G9. Utilizar somente com lâmpadas LED.
Material: vidro.

SD8313

SD8323

SD8333

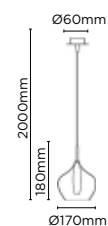
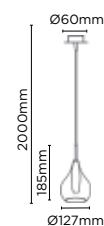
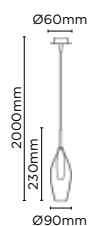

PENDENTE DE VIDRO DUPLO

Lâmpada indicada: 6 X G9. Utilizar somente com lâmpadas LED.
Material: vidro.

SD8303





PENDENTE MARMO

LANÇAMENTO

Lâmpada indicada: 1 X E27 Filamento Stella.
Material predominante: pedra natural.
Inclusa canopla.

SD8207	BRANCO
SD8208	AMARELO
SD8209	PRETO

Por tratar-se de um processo manual de produção, é possível encontrar algumas variações na peça.

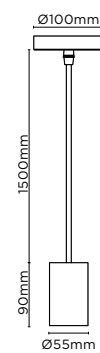



PENDENTE FILETTATO

Lâmpada indicada: 1 X E27 Filamento Stella.
Material: metal.
Canopla não inclusa.

SD8160	DOURADO	①
SD8161	CROMADO	②
SD8162	BRONZE	③
SD8163	GRAFITE	④
SD8164	COBRE	⑤

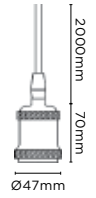

CANOPLAS

CANOPLA PENDENTE ÚNICO

SD8597	PRETO FOSCO
--------	-------------

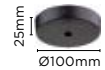

CANOPLA PENDENTE COMPOSTO (ATÉ 6 UNIDADES)

SD8598	PRETO FOSCO
SD8599	CROMADO



PENDENTE TRUZZO

Lâmpada indicada: 1 X E27 Filamento Stella.
Material predominante: concreto.
Canopla não inclusa.

SD8205

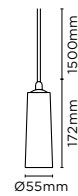

CANOPLAS

CANOPLA PENDENTE ÚNICO

SD8597	PRETO FOSCO
--------	-------------

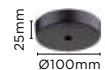

CANOPLA PENDENTE COMPOSTO (ATÉ 6 UNIDADES)

SD8598	PRETO FOSCO
SD8599	CROMADO





Produto Stella: Pendente Block, Concreto Natural

PENDENTE BLOCK CONCRETO

Lâmpada indicada: 1 X E27 Bulbo.
Material: concreto.

SD8060	DOURADO
SD8065	NATURAL

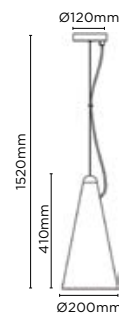

PENDENTE MUDRA

Lâmpada indicada: 1 X G9.
Material: concreto.

SD8080

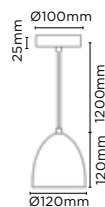



Produtos Stella, Plafons Concrete com lâmpadas Dioproica



PLAFON CONCRETE

Lâmpada indicada: 1 X MR16 GU10.
Material: concreto.

SD8070	QUADRADO
SD8075	REDONDO

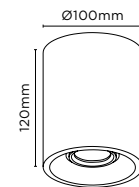
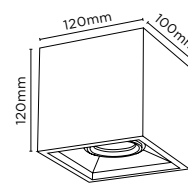

SEMIEMBUTIDO NAMU

Lâmpada indicada: 1 X MR16 GU10.
Material: concreto.

SD4704Q	QUADRADO
SD4704R	REDONDO

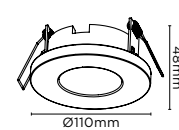
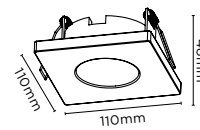

PLAFON NAMU

Lâmpada indicada: 1 X MR16 GU10.
Material: concreto e metal.

SD8003

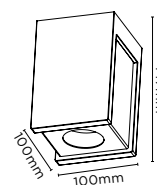



ARANDELA GREZZO

Lâmpada indicada: 1 X MR16 GU10.
Material predominante: concreto.

SD2350	CONCRETO
SD2355	AREIA

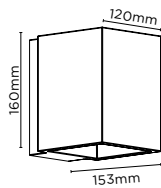

IP44

USO EXTERNO!

Com índice de proteção IP44, a Arandela Grezzo pode ser utilizada em áreas externas, resistindo a respingos de água e sólidos de até 1mm.



Produtos Stella Arandélas Plane | Arquiteta: Adriana Klaus
Mostra EliteDesign 2018 | Foto: RPPOLIS Imagens

ARANDELA PLANE

SD2320 ¹	BRANCO	QUADRADO
SD2330 ²	CONCRETO	QUADRADO
SD2340 ¹	DOURADO	QUADRADO
SD2325 ¹	BRANCO	RETANGULAR
SD2335 ²	CONCRETO	RETANGULAR
SD2345 ¹	DOURADO	RETANGULAR

Potência	9W (quadrado) e 12W (retangular)
Tensão	127V ou 220V
Fluxo luminoso	450lm
Temperatura de cor	3000K
Material	Gesso ¹ e concreto ²

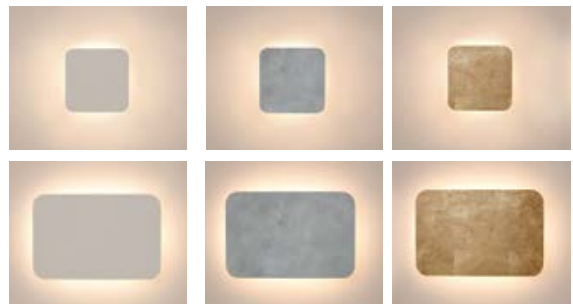
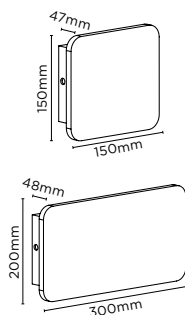



PENDENTE CIONERO

Lâmpada indicada: 10 ou 15 X E27 Mini Bulbo Filamento Stella.
Material: aço e vidro.
Inclusas três hastes (120mm, 320mm e 520mm).

SD8375

10 LÂMPADAS

SD8376

15 LÂMPADAS

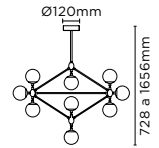
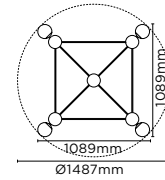
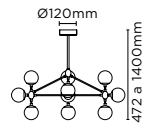
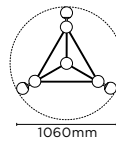

PENDENTE OLLIE

Lâmpada indicada: 8 X E14 Vela Filamento Stella.
Material: metal e vidro.
Inclusas duas hastes (500mm cada).

SD8830

VIDRO CONHAQUE

SD8831

BRANCO FOSCO

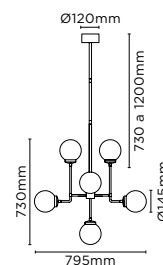



PENDENTE BLUNT

Lâmpada indicada: 6 X E27 Filamento Stella.
Material: metal.

SD8154	PRETO FOSCO
SD8155	DOURADO ESCOVADO
SD8156	COBRE ESCOVADO

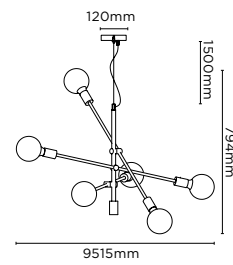

PENDENTE MUSA

Lâmpada indicada: 4 X G9.
Material: metal e vidro.

SD8157

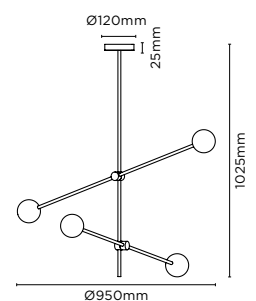

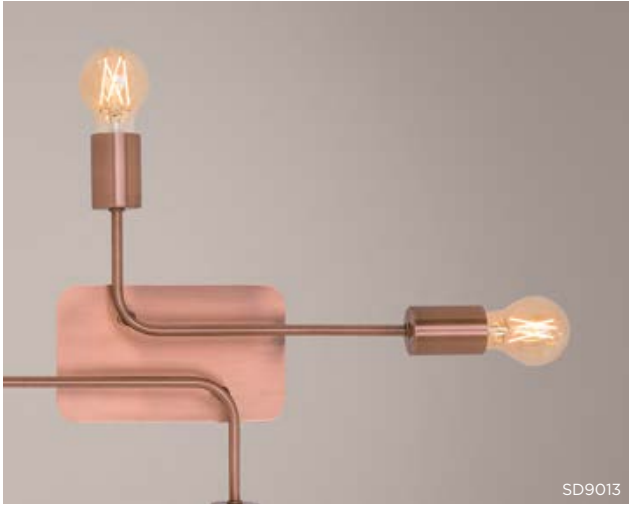

SD9013



SD9016

ARANDELA/PLAFON ELETRO

LANÇAMENTO

Lâmpada indicada: 4 ou 6 X E27 Filamento Stella.
Material: metal.

SD9013	COBRE	4 BRAÇOS
SD9014	PRETO FOSCO	4 BRAÇOS
SD9015	COBRE	6 BRAÇOS
SD9016	PRETO FOSCO	6 BRAÇOS

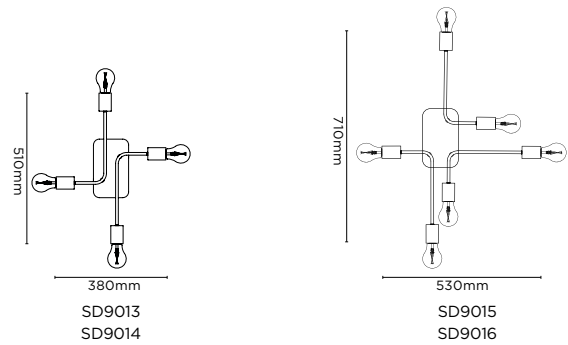

Projeto Stella, Plafon Eletro Cobre 6 Braços | Arquiteta: Fabi Hess / Mestre Glass Home 2018 | Foto: RPDOS Imagens



SD9005

PLAFON ELETRO

Lâmpada indicada: 6 ou 8 X E27 Filamento Stella.
Material: metal.

SD9002	PRETO FOSCO	6 BRAÇOS
SD9003	COBRE	6 BRAÇOS
SD9005	PRETO FOSCO	8 BRAÇOS
SD9006	COBRE	8 BRAÇOS

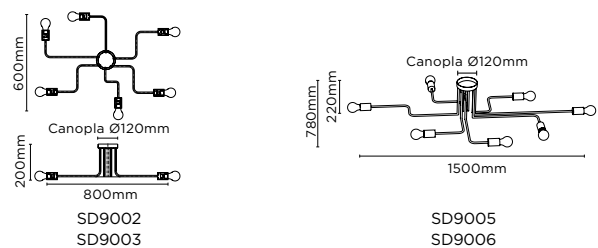



PENDENTE SUKA

Lâmpada indicada: 1 X E27 Filamento Stella.
Material: vidro e alumínio.

SD8317

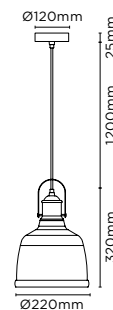

PENDENTE TRIKO

Lâmpada indicada: 3 X E27 Filamento Stella.
Material: vidro e metal.

SD8316

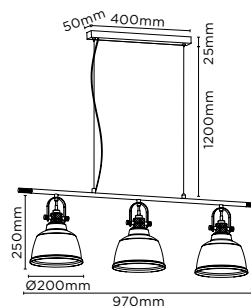

PENDENTE CAVINERI

Lâmpada indicada: 1 X E27 Filamento Stella.
Material: metal e alumínio.

SD8505

PERSONALIZE!

Além do alto apelo estético, com o sistema de roldanas do Pendente Cavineri você pode, de maneira prática, alterar a altura do pendente, sem a necessidade de cortar fios ou retirar a canopla.

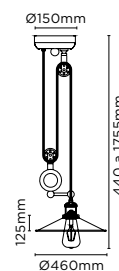

ARANDELA VOLUSPA

Lâmpada indicada: 1 X E27 Filamento Stella.
Material predominante: metal.

SD2105

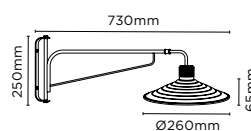



PENDENTE GEMINI

Lâmpada indicada: 2 X E27 Filamento Stella.
Material predominante: metal.

SD8625

PERSONALIZE!

O pendente é direcionável e permite o ajuste da altura e posição dos braços.

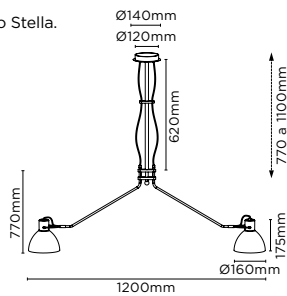

PENDENTE CHANTI

Lâmpada indicada: 1 X E27 Filamento Stella.
Material predominante: aço.

SD8506

PERSONALIZE!

O pendente é articulável, permitindo ajustes de posição.

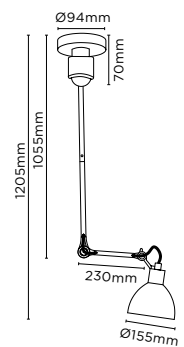

ARANDELA HALA

Lâmpada indicada: 1 X E27 Filamento Stella.
Material predominante: aço.

SD2107

PERSONALIZE!

O pendente é articulável, permitindo ajustes de posição.

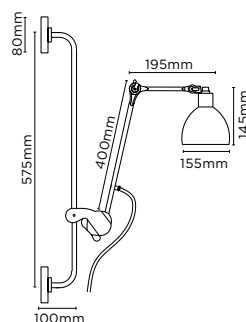

ARANDELA SAVA

Lâmpada indicada: 1 X E27 Filamento Stella.
Material predominante: aço.

SD2108

PERSONALIZE!

A arandela é direcionável e permite o ajuste da extensão do braço.

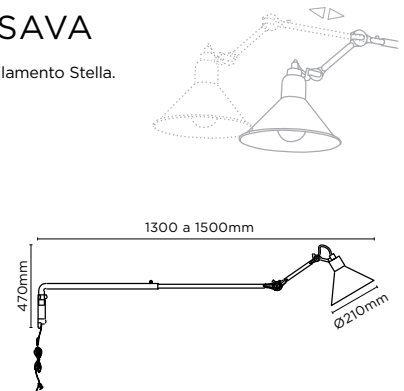



LUMINÁRIA KLUG

Lâmpada indicada: 1 X E27 Filamento Stella.
Material predominante: metal.

SD2220	BRANCO
SD2215	PRETO

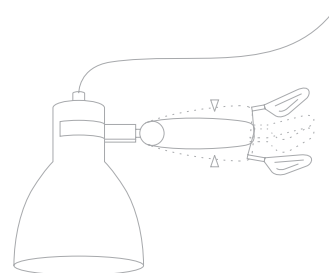
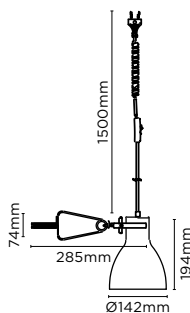

PARA PLUGAR!

A luminária possui presilha de força, com abertura de até 6cm, que permite fixação em prateleiras ou nichos.



ARANDELA LED DANA E JOLLY ARTICULÁVEIS

SD2260 - DANA	CROMADO
SD2261 - DANA	BRANCO
SD2262 - DANA	PRETO
SD2200 - JOLLY	CROMADO
SD2210 - JOLLY	BRANCO

Potência 3W (DANA) e 5W (JOLLY)
Temperatura de cor 3000K
Material Alumínio e metal

Inclusa canopla.



COLUNA FLYTE

Lâmpada indicada: 1 X E27 Filamento Stella.
Material predominante: alumínio.

SD6315

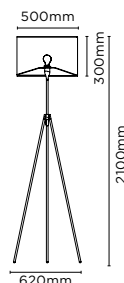

PERSONALIZE!
A coluna permite o ajuste da altura da cúpula.

SEMIEMBUTIDO DE CRISTAL

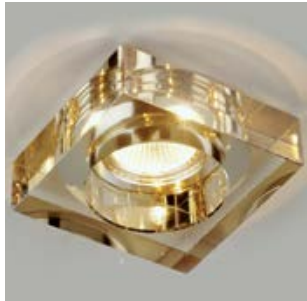

SD4000Q	TRANSLÚCIDO
SD4007Q	CHAMPAGNE

Lâmpada indicada: 1 X MR16 GU10.
Material predominante: cristal.

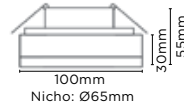

SD4000R	TRANSLÚCIDO
SD4007R	CHAMPAGNE

Lâmpada indicada: 1 X MR16 GU10.
Material predominante: cristal.

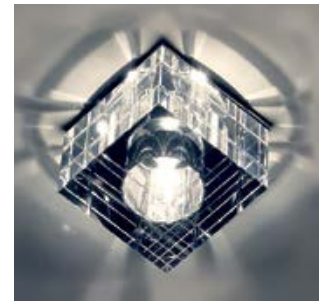
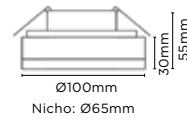

SD4002Q

Lâmpada indicada: 1 X MR11 GU10.
Material predominante: cristal.

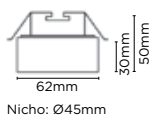

SD4010

Lâmpada indicada: 1 X G4.
Material predominante: cristal.

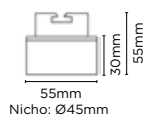

SD4011

Lâmpada indicada: 1 X G9.
Material predominante: cristal.

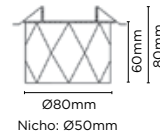

SD4020

Lâmpada indicada: 1 X G9.
Material predominante: cristal.

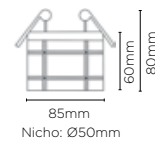

Produto Stylla. Semiembutido Freja com Cristais
Foto: P&P OIS Imagens



SD7530

PLAFON DAGDA

Lâmpada indicada: 1 X G9.
Material predominante: cristal e vidro.

SD7500	CRISTAL TRANSLÚCIDO E VIDRO TRANSPARENTE
SD7530	CRISTAL TRANSLÚCIDO E VIDRO COM ACABAMENTO DOURADO



SD7500

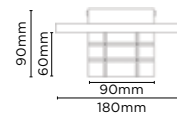

SD4030Q



SD4031Q



SD4032Q

SEMIEMBUTIDO FREYA COM CRISTAIS

Lâmpada indicada: 1 X G9.
Material predominante: cristal.

SD4030Q	TRANSLÚCIDO
SD4031Q	CHAMPAGNE
SD4032Q	GRAFITE

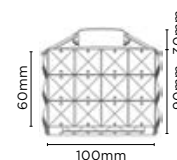

SD8900

PENDENTE FREYA COM CRISTAIS

Lâmpada indicada: 1 X G9.
Material predominante: cristal.

SD8900	TRANSLÚCIDO
SD8901	CHAMPAGNE
SD8902	GRAFITE

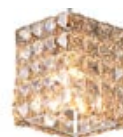

SD8901



SD8902

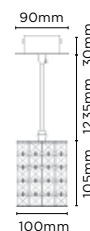



SD8353

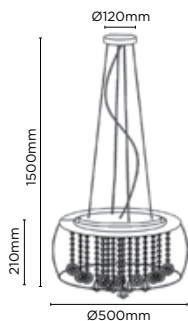

PENDENTE/PLAFON AGLAIA

Lâmpada indicada: 6 X G9.
Material: vidro e cristal.
Incluído kit pendente/plafon.

SD8350	CROMADO COM CRISTAIS TRANSLÚCIDOS
SD8352	CHAMPAGNE COM CRISTAIS CHAMPAGNE
SD8353	COBRE COM CRISTAIS TRANSLÚCIDOS



SD8350



SD8352



Produto: Stella - Plafon.com Cristais | Arquiteta: Raífaela Erdmann
Mostra Lifestage 2017 | Foto: RFDOS Imagens



PLAFON COM CRISTAIS

Lâmpada indicada: 16 X G9.
Material predominante: cristal.

SD7025	CRISTAIS TRANSLÚCIDOS E CHAMPAGNE
---------------	-----------------------------------

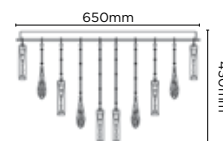

PENDENTE COM CRISTAIS TRANSLÚCIDOS

Lâmpada indicada: 8' ou 12' X G9.
Material predominante: cristal.

SD9010'	SD9020²



PLAFON CIRCE

Lâmpada indicada: 6 X G9.
Material: cristal e metal.

SD9703	DOURADO COM CRISTAIS TRANSLÚCIDOS
SD9704	CROMADO COM CRISTAIS TRANSLÚCIDOS

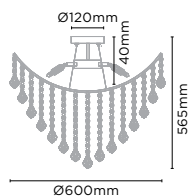

PENDENTE CIRCE DOURADO COM CRISTAIS TRANSLÚCIDOS

Lâmpada indicada: 6¹ ou 8² X G9.
Material: cristal e metal.

SD9050¹	SD9060²
---------------------------	---------------------------

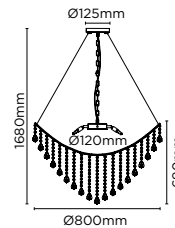
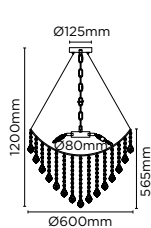

PENDENTE CIRCE CROMADO COM CRISTAIS TRANSLÚCIDOS

Lâmpada indicada: 6³ ou 8⁴ X G9.
Material: cristal e metal.

SD9055³	SD9065⁴
---------------------------	---------------------------

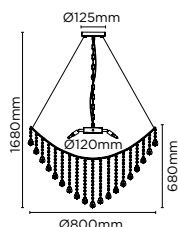
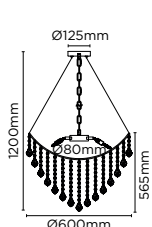

LUSTRE ÉROS CROMADO COM CRISTAIS CONHAQUE

Lâmpada indicada: 4 X E14 Vela Filamento Stella.
Material: cristal e metal.

SD9460

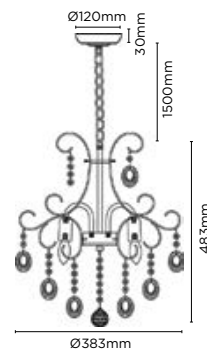



LUSTRE PIEDRA PRATA

LANÇAMENTO

Lâmpada indicada: 4 X G9.
Material: cristal e metal.

SD9473

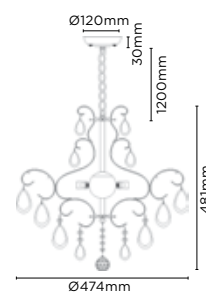



SD9470



SD9475



SD9476

LUSTRE PIEDRA DOURADO

Lâmpada indicada: 4^l, 12² ou 16³ X G9.
Material predominante: cristal e metal.

SD9470 ¹
SD9475 ²
SD9476 ³

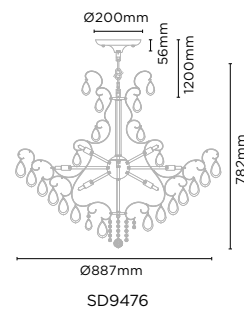
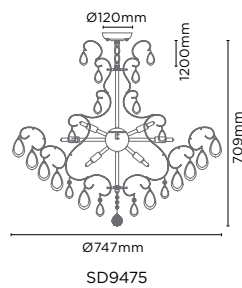
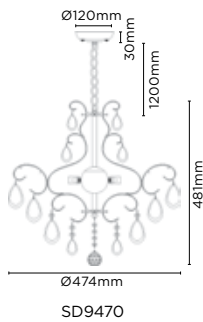

PLAFON PIEDRA DOURADO

Lâmpada indicada: 4 X G9.
Material: cristal e metal.

SD9705

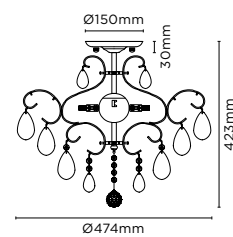



LUSTRE RAFINNATO

Lâmpada indicada: 3, 6, 8, 12, 15 ou 28 X E14 Filamento Stella.
Material predominante: cristal.

3 BRAÇOS	6 BRAÇOS	8 BRAÇOS	12 (8+4) BRAÇOS	15 (10+5) BRAÇOS	28 (16+8+4) BRAÇOS
TRANSLÚCIDO SD9810/03	TRANSLÚCIDO SD9810/06	TRANSLÚCIDO SD9810/08	TRANSLÚCIDO SD9810/12	TRANSLÚCIDO SD9810/15	TRANSLÚCIDO SD9810/28
CHAMPAGNE SD9825/03	CHAMPAGNE SD9825/06	CHAMPAGNE SD9825/08	CHAMPAGNE SD9825/12	CHAMPAGNE SD9825/15	
	GRAFITE SD9815/06		GRAFITE SD9815/12		

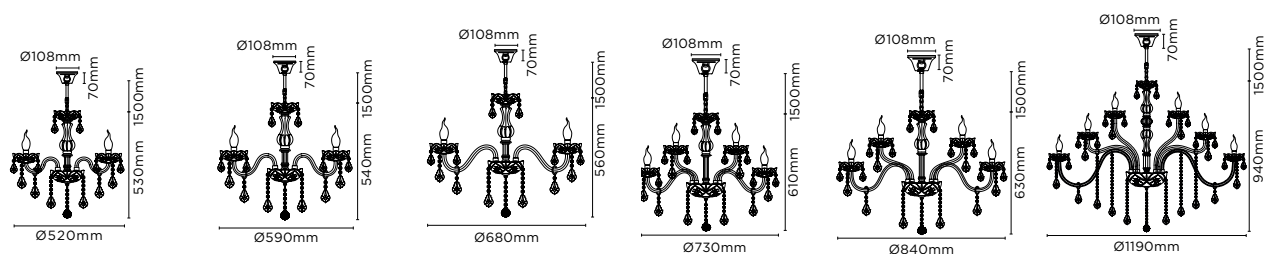



LUSTRE RAFINATO

Lâmpada indicada: 35 X E14 Filamento Stella.
Material predominante: cristal.

35 (20+10+5) BRAÇOS

TRANSLÚCIDO

SD9810/35

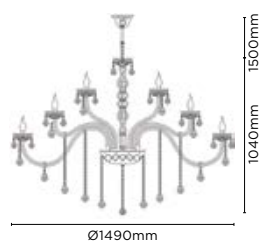

ARANDELA RAFINATO

Lâmpada indicada: 1 X E14 Vela Filamento Stella.
Material predominante: cristal.

SD2810/01

TRANSLÚCIDO

SD2825/01

CHAMPAGNE

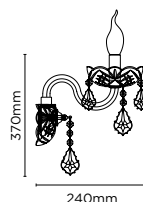

GRÁFICOS LUMINOTÉCNICOS

122 LÂMPADAS

125 LUMINÁRIAS

126 JARDIM

128 TRILHOS

GRÁFICOS DE EFEITOS

129 SQUARE

130 SQUARE GHOST

SQUARE ANGLE



LÂMPADAS

Pág. 06

STH7530/27

1,0m	583lx	54cm
2,0m	145lx	108cm
3,0m	64lx	162cm
4,0m	36lx	216cm
5,0m	23lx	270cm

Altura, Emax e Diâmetro

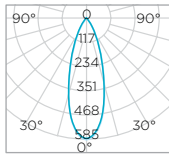

— CO/180 — C90/270

STH7535/27

1,0m	1017lx	65cm
2,0m	254lx	130cm
3,0m	118lx	194cm
4,0m	63lx	259cm
5,0m	40lx	324cm

Altura, Emax e Diâmetro

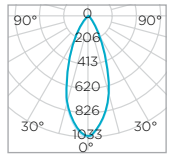

— CO/180 — C90/270

Pág. 07

STH6435/27

1,0m	3425lx	22cm
2,0m	856lx	43cm
3,0m	380lx	65cm
4,0m	214lx	86cm
5,0m	137lx	108cm

Altura, Emax e Diâmetro

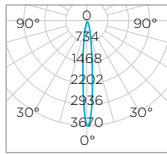

— CO/180 — C90/270

STH6436/27

1,0m	1290lx	43cm
2,0m	322lx	86cm
3,0m	143lx	130cm
4,0m	80lx	173cm
5,0m	51lx	216cm

Altura, Emax e Diâmetro

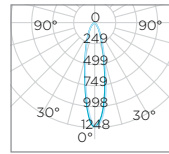

— CO/180 — C90/270

STH6445/27

1,0m	5451lx	22cm
2,0m	1362lx	43cm
3,0m	605lx	65cm
4,0m	340lx	86cm
5,0m	218lx	108cm

Altura, Emax e Diâmetro

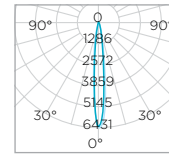

— CO/180 — C90/270

STH6446/27

1,0m	1886lx	43cm
2,0m	471lx	86cm
3,0m	209lx	130cm
4,0m	117lx	173cm
5,0m	75lx	216cm

Altura, Emax e Diâmetro

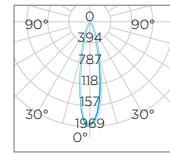

— CO/180 — C90/270

Pág. 08

STH7080/27

1,0m	1406lx	40cm
2,0m	352lx	90cm
3,0m	156lx	130cm
4,0m	88lx	170cm
5,0m	56lx	210cm

Altura, Emax e Diâmetro

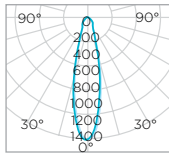

— CO/180 — C90/270

STH7085/27

1,0m	2782lx	40cm
2,0m	696lx	90cm
3,0m	309lx	130cm
4,0m	174lx	170cm
5,0m	111lx	215cm

Altura, Emax e Diâmetro

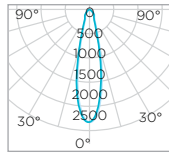

— CO/180 — C90/270

Pág. 09

STH8513/27, /30, /40, /65

1,0m	579lx	54cm
2,0m	140lx	108cm
3,0m	59lx	162cm
4,0m	31lx	216cm
5,0m	19lx	270cm

Altura, Emax e Diâmetro

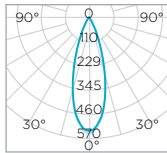

— CO/180 — C90/270

STH6515/27

1,0m	519lx	54cm
2,0m	129lx	108cm
3,0m	57lx	162cm
4,0m	32lx	216cm
5,0m	20lx	270cm

Altura, Emax e Diâmetro

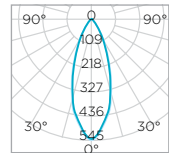

— CO/180 — C90/270

STH8533/27, /30, /65

1,0m	527lx	64cm
2,0m	131lx	129cm
3,0m	58lx	194cm
4,0m	32lx	259cm
5,0m	21lx	324cm

Altura, Emax e Diâmetro

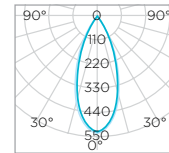

— CO/180 — C90/270

Pág. 10

STH8534/27, /30, /40, /65

1,0m	766lx	64cm
2,0m	191lx	129cm
3,0m	85lx	194cm
4,0m	47lx	259cm
5,0m	30lx	324cm

Altura, Emax e Diâmetro

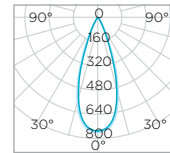

— CO/180 — C90/270

Pág. 10

STH8537/30

1,0m	398lx	110cm
2,0m	99lx	220cm
3,0m	44lx	330cm
4,0m	25lx	440cm
5,0m	16lx	550cm

Altura, Emax e Diâmetro

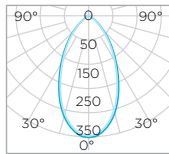

— CO/180 — C90/270

STH8538/30

1,0m	452lx	110cm
2,0m	113lx	220cm
3,0m	50lx	330cm
4,0m	29lx	440cm
5,0m	19lx	550cm

Altura, Emax e Diâmetro

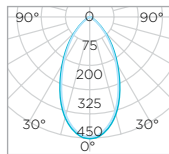

— CO/180 — C90/270

STH8535/27, /30 /40, /65

1,0m	943lx	64cm
2,0m	235lx	129cm
3,0m	104lx	194cm
4,0m	58lx	259cm
5,0m	37lx	324cm

Altura, Emax e Diâmetro

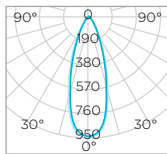

— CO/180 — C90/270

Pág. 11

STH8541/27
STH8542/27

1,0m	943lx	64cm
2,0m	235lx	129cm
3,0m	104lx	194cm
4,0m	58lx	259cm
5,0m	37lx	324cm

Altura, Emax e Diâmetro

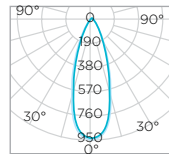

— CO/180 — C90/270

STH8528/27

1,0m	3063lx	24cm
2,0m	765lx	48cm
3,0m	340lx	72cm
4,0m	191lx	96cm
5,0m	122lx	120cm

Altura, Emax e Diâmetro

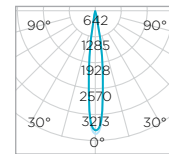

— CO/180 — C90/270

STH8526/27, /30

1,0m	943lx	64cm
2,0m	235lx	129cm
3,0m	104lx	194cm
4,0m	58lx	259cm
5,0m	37lx	324cm

Altura, Emax e Diâmetro

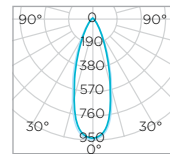

— CO/180 — C90/270

Pág. 11

STH8060/27

1,0m	920lx	65cm
2,0m	230lx	113cm
3,0m	102lx	197cm
4,0m	57lx	262cm
5,0m	36lx	328cm

Altura, Emax e Diâmetro

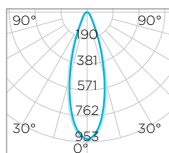

— CO/180 — C90/270

Pág. 12

STH8020/27, /30, /40, /65

1,0m	1477lx	45cm
2,0m	369lx	90cm
3,0m	164lx	135cm
4,0m	92lx	180cm
5,0m	59lx	225cm

Altura, Emax e Diâmetro

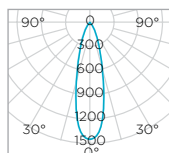

— CO/180 — C90/270

STH8024/30, /40

1,0m	962lx	70cm
2,0m	241lx	150cm
3,0m	107lx	220cm
4,0m	60lx	300cm
5,0m	38lx	370cm

Altura, Emax e Diâmetro

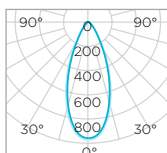

— CO/180 — C90/270

STH8030/27, /30, /40, /65

1,0m	2533lx	45cm
2,0m	633lx	90cm
3,0m	281lx	135cm
4,0m	158lx	180cm
5,0m	101lx	225cm

Altura, Emax e Diâmetro

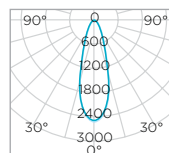

— CO/180 — C90/270

STH8035/30

1,0m	3728lx	45cm
2,0m	932lx	90cm
3,0m	414lx	135cm
4,0m	233lx	180cm
5,0m	149lx	225cm

Altura, Emax e Diâmetro

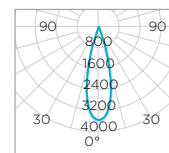

— CO/180 — C90/270

Pág. 13

STH8433/27

1,0m	1722lx	30cm
2,0m	430lx	50cm
3,0m	191lx	80cm
4,0m	108lx	100cm
5,0m	69lx	130cm

Altura, Emax e Diâmetro

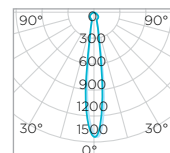

— CO/180 — C90/270

STH8434/27

1,0m	910lx	40cm
2,0m	227lx	80cm
3,0m	101lx	110cm
4,0m	57lx	150cm
5,0m	36lx	190cm

Altura, Emax e Diâmetro

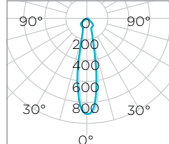

— C0/180 — C90/270

STH8443/27

1,0m	4764lx	20cm
2,0m	1191lx	40cm
3,0m	529lx	70cm
4,0m	298lx	90cm
5,0m	191lx	110cm

Altura, Emax e Diâmetro

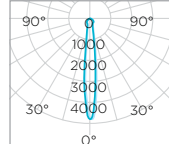

— C0/180 — C90/270

STH8444/27

1,0m	2225lx	40cm
2,0m	556lx	80cm
3,0m	247lx	110cm
4,0m	139lx	150cm
5,0m	89lx	190cm

Altura, Emax e Diâmetro

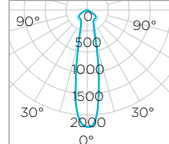

— C0/180 — C90/270

STH7121/24, /27, /30
STH7122/24, /27, /30

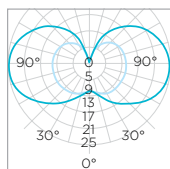

— C0/180 — C90/270

STH8151/24
STH8152/24

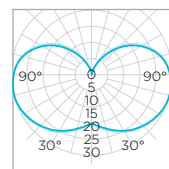

— C0/180 — C90/270

STH8141/30
STH8142/30

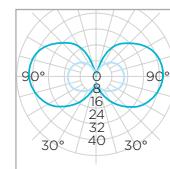

— C0/180 — C90/270

STH6103/27

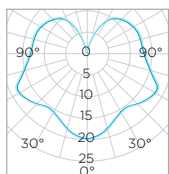

— C0/180 — C90/270

STH5120/27

1,0m	39lx	276cm
2,0m	14lx	454cm
3,0m	6lx	681cm
4,0m	3lx	908cm
5,0m	2lx	1135cm

Altura, Emax e Diâmetro

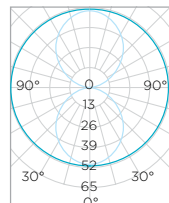

— C0/180 — C90/270

STH5130/27

1,0m	70lx	283cm
2,0m	26lx	464cm
3,0m	11lx	696cm
4,0m	6lx	928cm
5,0m	4lx	1160cm

Altura, Emax e Diâmetro

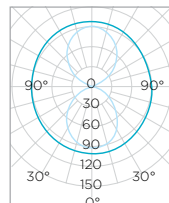

— C0/180 — C90/270

STH6140/27

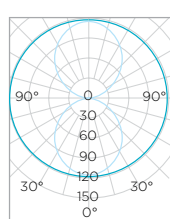

— C0/180 — C90/270

STH8220/27

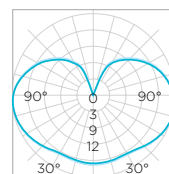

— C0/180 — C90/270

STH8226/27

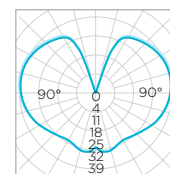

— C0/180 — C90/270

STH8285/24

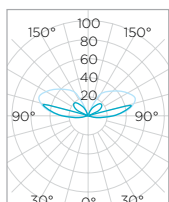

— C0/180 — C90/270

STH8290/24

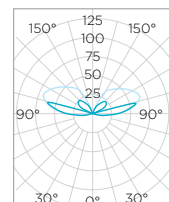

— C0/180 — C90/270

STH8383/24
STH8384/24

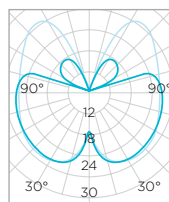

— C0/180 — C90/270

STH8393/24
STH8394/24

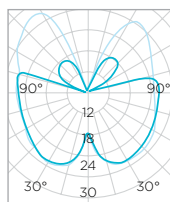

— C0/180 — C90/270

STH8381/24
STH8382/24

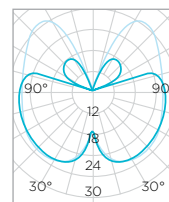

— C0/180 — C90/270

STH8391/24
STH8392/24

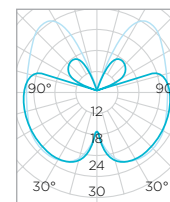

— C0/180 — C90/270

STH8240/24

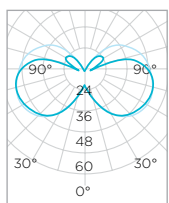

— C0/180 — C90/270

STH8242/24

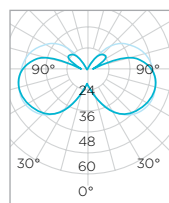

— C0/180 — C90/270

STH8244/24

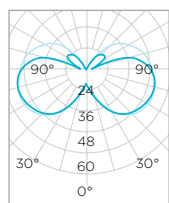

— C0/180 — C90/270

STH8246/24

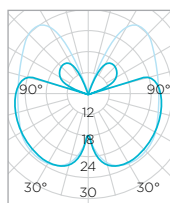

— C0/180 — C90/270

STH8247/24

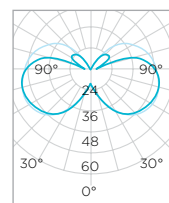

— C0/180 — C90/270

STH6301/24
STH6302/24

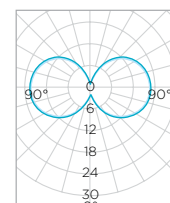

— C0/180 — C90/270

Pág. 20

STH6311/24
STH6312/24

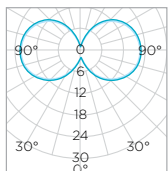

— C0/180 — C90/270

STH6321/24
STH6322/24

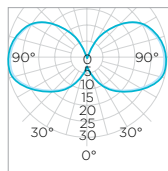

— C0/180 — C90/270

STH6331/24
STH6332/24

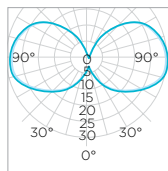

— C0/180 — C90/270

STH8361/24
STH8362/24

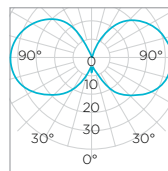

— C0/180 — C90/270

STH8371/24



— C0/180 — C90/270

Pág. 21

STH6334/24

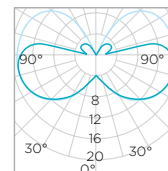

— C0/180 — C90/270

Pág. 21

STH6335/24

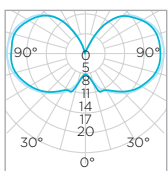

— C0/180 — C90/270

STH6338/24

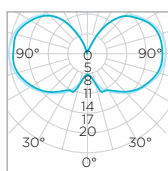

— C0/180 — C90/270

STH6336/24

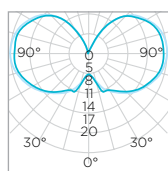

— C0/180 — C90/270

Pág. 22

STH6337/24

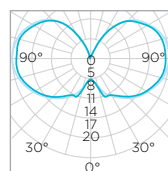

— C0/180 — C90/270

STH6339/24

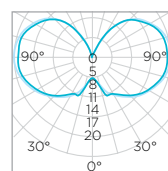

— C0/180 — C90/270

STH8261/24
STH8262/24

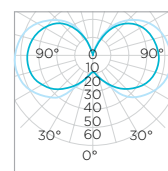

— C0/180 — C90/270

Pág. 22

STH8271/24
STH8272/24

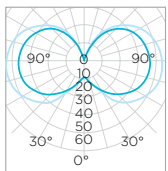

— C0/180 — C90/270

Pág. 23

STH8281/24
STH8282/24

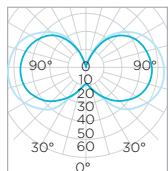

— C0/180 — C90/270

Pág. 24

STH7301/27
STH7302/27

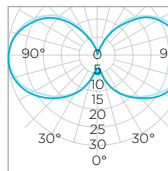

— C0/180 — C90/270

STH7311/27
STH7312/27

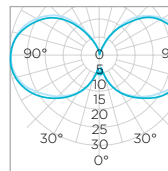

— C0/180 — C90/270

STH7210/27

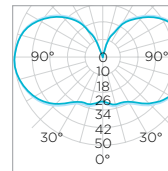

— C0/180 — C90/270

STH7212/27

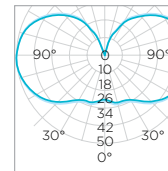

— C0/180 — C90/270

Pág. 25

STH7211/27

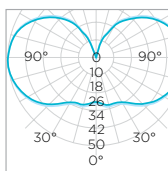

— C0/180 — C90/270

Pág. 26

STH7310/30

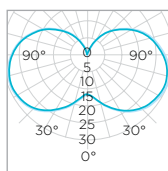

— C0/180 — C90/270

STH6300/27, /30

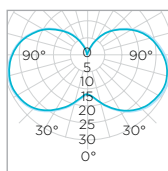

— C0/180 — C90/270

STH7351/27
STH7352/27

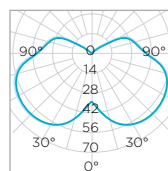

— C0/180 — C90/270

Pág. 27

STH9200/27, /30

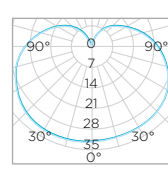

— C0/180 — C90/270

STH6260/27

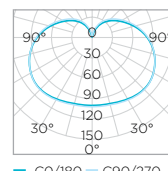

— C0/180 — C90/270

Pág. 27

STH8263/30, /40,
STH7253/65

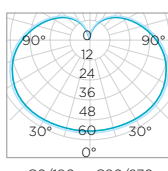

— C0/180 — C90/270

STH8264/27, /40
STH8234/30
STH7264/65

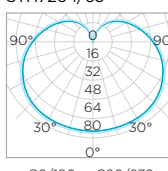

— C0/180 — C90/270

Pág. 28

STH8265/27, /30, /40,
STH7265/65

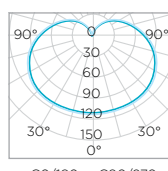

— C0/180 — C90/270

STH7250/27

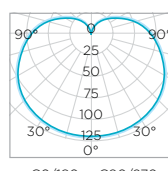

— C0/180 — C90/270

STH8236/30
STH7256/65

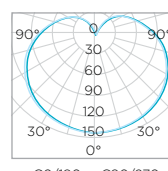

— C0/180 — C90/270

STH7238/65

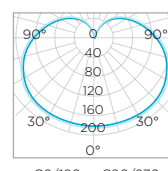

— C0/180 — C90/270

Pág. 29

STH8605/30, /65

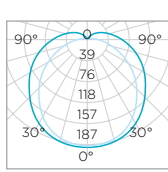

— C0/180 — C90/270

STH8615/30, /40, /65

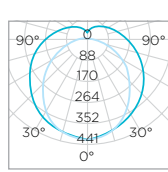

— C0/180 — C90/270

STH7607/30, /40, /65

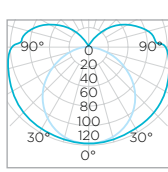

— C0/180 — C90/270

STH7617/30, /40, /65

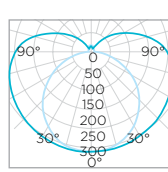

— C0/180 — C90/270

STH7292/65

1,0m	234lx	486cm
2,0m	58lx	972cm
3,0m	26lx	1458cm
4,0m	14lx	1944cm
5,0m	9lx	2430cm

Altura, Emax e Diâmetro

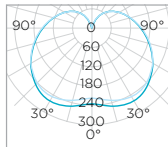

— CO/180 — C90/270

STH7293/65

1,0m	351lx	486cm
2,0m	87lx	972cm
3,0m	39lx	1458cm
4,0m	21lx	1944cm
5,0m	14lx	2430cm

Altura, Emax e Diâmetro

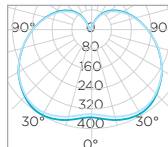

— CO/180 — C90/270

STH7294/65

1,0m	426lx	486cm
2,0m	106lx	972cm
3,0m	47lx	1458cm
4,0m	26lx	1944cm
5,0m	17lx	2430cm

Altura, Emax e Diâmetro

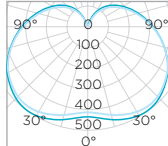

— CO/180 — C90/270

LUMINÁRIAS

STH8902/30, /40, /57

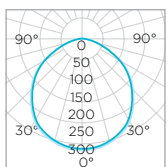

— CO/180 — C90/270

STH8903/30, /40, /57

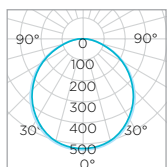

— CO/180 — C90/270

STH8904/30, /40, /57

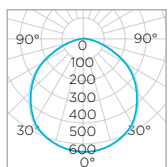

— CO/180 — C90/270

STH8905/30, /40, /57

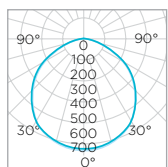

— CO/180 — C90/270

STH9951Q/30, /40, /65

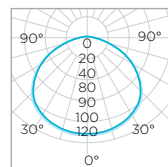

— CO/180 — C90/270

STH9952Q/30, /40, /65

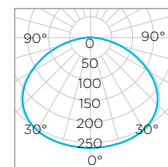

— CO/180 — C90/270

STH9953Q/30, /40, /65

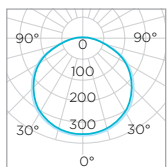

— CO/180 — C90/270

STH9954Q/30, /40, /65

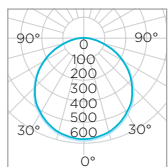

— CO/180 — C90/270

STH9954R/30, /40, /65

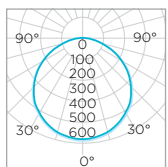

— CO/180 — C90/270

STH7957/30, /40, /57

1,0m	738lx	216cm
2,0m	184lx	432cm
3,0m	82lx	648cm
4,0m	46lx	864cm
5,0m	26lx	1080cm

Altura, Emax e Diâmetro

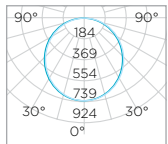

— CO/180 — C90/270

STH7958/30, /40, /57

1,0m	1034lx	216cm
2,0m	258lx	432cm
3,0m	114lx	648cm
4,0m	64lx	864cm
5,0m	41lx	1080cm

Altura, Emax e Diâmetro

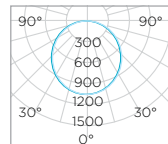

— CO/180 — C90/270

STH9956/30, /40, /57

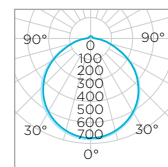

— CO/180 — C90/270

STH7959/40,

1,0m	1034lx	216cm
2,0m	258lx	432cm
3,0m	114lx	648cm
4,0m	64lx	864cm
5,0m	41lx	1080cm

Altura, Emax e Diâmetro

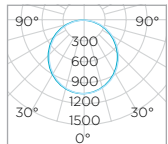

— CO/180 — C90/270

STH8962Q/30, /40, /65

1,0m	281lx	216cm
2,0m	70lx	432cm
3,0m	31lx	648cm
4,0m	17lx	864cm
5,0m	11lx	1080cm

Altura, Emax e Diâmetro

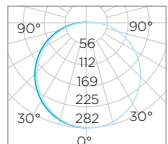

— CO/180 — C90/270

STH8963Q/30, /40, /65

1,0m	438lx	216cm
2,0m	109lx	432cm
3,0m	48lx	648cm
4,0m	27lx	864cm
5,0m	17lx	1080cm

Altura, Emax e Diâmetro

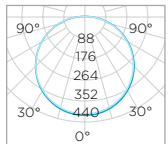

— CO/180 — C90/270

STH8964Q/30, /40, /65

1,0m	579lx	216cm
2,0m	144lx	432cm
3,0m	64lx	648cm
4,0m	36lx	864cm
5,0m	23lx	1080cm

Altura, Emax e Diâmetro

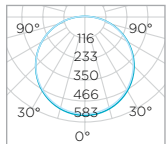

— CO/180 — C90/270

STH7967/30, /40, /57

1,0m	816lx	216cm
2,0m	204lx	432cm
3,0m	90lx	648cm
4,0m	51lx	864cm
5,0m	32lx	1080cm

Altura, Emax e Diâmetro

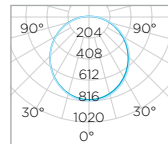

— CO/180 — C90/270

STH7968/30, /40, /57

1,0m	879lx	216cm
2,0m	220lx	432cm
3,0m	98lx	648cm
4,0m	55lx	864cm
5,0m	35lx	1080cm

Altura, Emax e Diâmetro

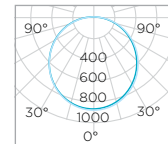

— CO/180 — C90/270

STH6970/27
STH6971/27

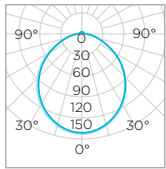

— C0/180 — C90/270

STH6974/27
STH6975/27

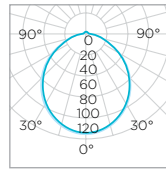

— C0/180 — C90/270

STH6978/27
STH6979/27

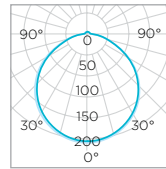

— C0/180 — C90/270

STH6900/30
STH6901/30
STH6902/30

1,0m	287lx	54cm
2,0m	71lx	108cm
3,0m	31lx	162cm
4,0m	17lx	216cm
5,0m	11lx	270cm

Altura, Emax e Diâmetro

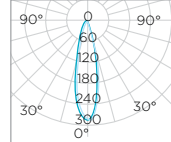

— C0/180 — C90/270

STH7905/30
STH7906/30

1,0m	51lx	216cm
2,0m	12lx	432cm
3,0m	5lx	648cm
4,0m	3lx	864cm
5,0m	2lx	1080cm

Altura, Emax e Diâmetro

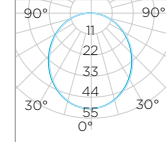

— C0/180 — C90/270

STH7930/30, /40, /57

1,0m	470lx	310cm
2,0m	117lx	630cm
3,0m	52lx	940cm
4,0m	29lx	1280cm
5,0m	19lx	1570cm

Altura, Emax e Diâmetro

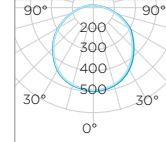

— C0/180 — C90/270

STH7940/30, /40, /57

1,0m	896lx	320cm
2,0m	224lx	640cm
3,0m	100lx	960cm
4,0m	56lx	1270cm
5,0m	36lx	1590cm

Altura, Emax e Diâmetro

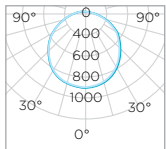

— C0/180 — C90/270

STH7910/30

1,0m	385lx	68cm
2,5m	66lx	171cm
3,0m	42lx	204cm
4,0m	24lx	273cm

Altura, Emax e Diâmetro

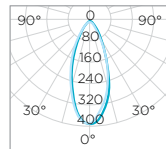

— C0/180 — C90/270

STH7915/30

1,0m	730lx	68cm
2,0m	182lx	137cm
3,0m	81lx	205cm

Altura, Emax e Diâmetro

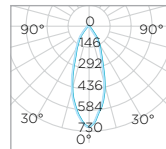

— C0/180 — C90/270

STH7920/30

1,0m	1082lx	54cm
2,0m	270lx	108cm
3,0m	120lx	162cm
4,0m	67lx	216cm
5,0m	43lx	270cm

Altura, Emax e Diâmetro

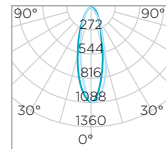

— C0/180 — C90/270

STH7925/30

1,0m	1583lx	54cm
2,0m	395lx	108cm
3,0m	175lx	162cm

Altura, Emax e Diâmetro

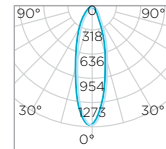

— C0/180 — C90/270

JARDIM

STH9740BR/30
STH9740PTO/30

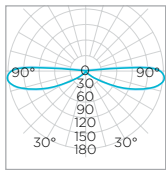

— C0/180 — C90/270

STH9741BR/30
STH9741PTO/30

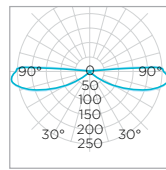

— C0/180 — C90/270

STH5726/30
STH9726/30

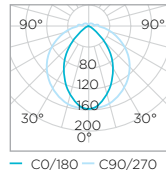

— C0/180 — C90/270

STH7700/30, /40

1,0m	147lx	380cm
2,0m	37lx	770cm
3,0m	16lx	1150cm
4,0m	9lx	1530cm
5,0m	6lx	1920cm

Altura, Emax e Diâmetro

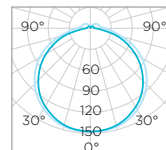

— C0/180 — C90/270

STH9730BR/30
STH9730PTO/30

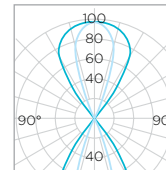

— C0/180 — C90/270

STH9731BR/30
STH9731PTO/30

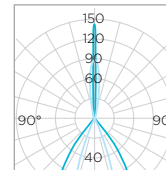

— C0/180 — C90/270

STH9732BR/30
STH9732PTO/30

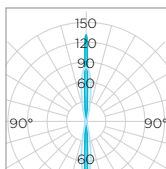

— C0/180 — C90/270

STH6734/30
STH6735/30

1,0m	1795lx	20cm
2,0m	449lx	30cm
3,0m	199lx	50cm
4,0m	112lx	70cm
5,0m	72lx	90cm

Altura, Emax e Diâmetro

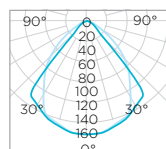

— C0/180 — C90/270

STH6730/30
STH6731/30
STH7736/30
STH7737/30

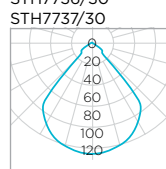

— C0/180 — C90/270

STH6732/30
STH6733/30

1,0m	1795lx	20cm
2,0m	449lx	30cm
3,0m	199lx	50cm
4,0m	112lx	70cm
5,0m	72lx	90cm

Altura, Emax e Diâmetro

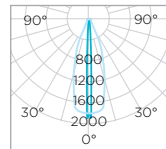

— C0/180 — C90/270

STH8740/30
STH8741/30

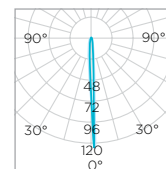

— C0/180 — C90/270

STH8745/30
STH8746/30

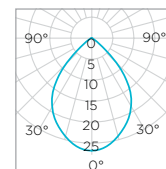

— C0/180 — C90/270

STH8750/30
STH8751/30

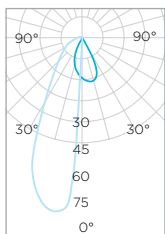

— C0/180 — C90/270

STH8755/30
STH8756/30

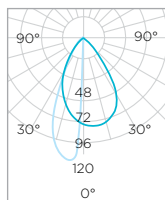

— C0/180 — C90/270

STH8702/27
STH8703/27

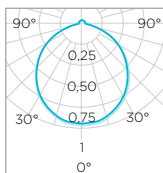

— C0/180 — C90/270

STH7710/30

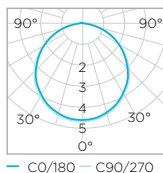

— C0/180 — C90/270

STH6710/30

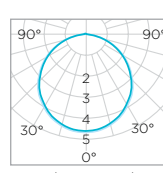

— C0/180 — C90/270

STH7709/30

1,0m	293lx	40cm
2,0m	73lx	90cm
3,0m	33lx	130cm
4,0m	18lx	170cm
5,0m	12lx	210cm

Altura, Emax e Diâmetro

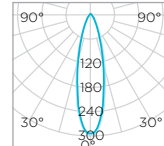

— C0/180 — C90/270

STH6720/30

1,0m	293lx	40cm
2,0m	73lx	90cm
3,0m	33lx	130cm
4,0m	18lx	170cm
5,0m	12lx	210cm

Altura, Emax e Diâmetro

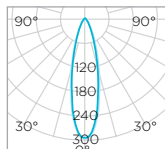

— C0/180 — C90/270

STH7704/30

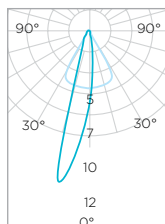

— C0/180 — C90/270

STH7705/30

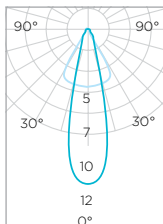

— C0/180 — C90/270

STH5725/30

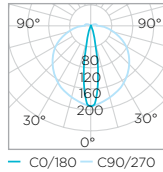

— C0/180 — C90/270

STH5720/30

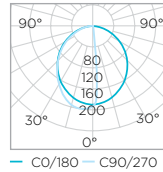

— C0/180 — C90/270

STH9725BR/30
STH9725PTO/30

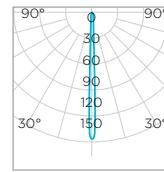

— C0/180 — C90/270

STH7761/30, /65
STH7741/30, /65

1,0m	369lx	198cm
2,0m	92lx	396cm
3,0m	41lx	594cm
4,0m	23lx	792cm
5,0m	14lx	990cm

Altura, Emax e Diâmetro

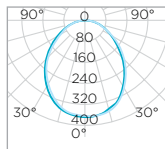

— C0/180 — C90/270

STH7742/30, /65

1,0m	770lx	198cm
2,0m	192lx	396cm
3,0m	85lx	594cm
4,0m	48lx	792cm
5,0m	30lx	990cm

Altura, Emax e Diâmetro

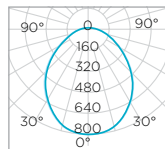

— C0/180 — C90/270

STH7763/30, /65
STH7743/30, /65

1,0m	1124lx	198cm
2,0m	280lx	396cm
3,0m	124lx	594cm
4,0m	70lx	792cm
5,0m	44lx	990cm

Altura, Emax e Diâmetro

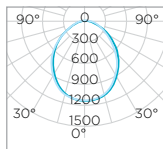

— C0/180 — C90/270

STH7765/30, /65
STH7745/30, /65

1,0m	1793lx	198cm
2,0m	448lx	396cm
3,0m	199lx	594cm
4,0m	112lx	792cm
5,0m	71lx	990cm

Altura, Emax e Diâmetro

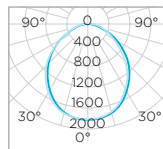

— C0/180 — C90/270

STH8723/30
STH8724/30

1,0m	826lx	60cm
2,0m	206lx	120cm
3,0m	92lx	190cm
4,0m	52lx	250cm
5,0m	33lx	310cm

Altura, Emax e Diâmetro

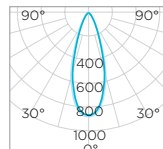

— C0/180 — C90/270

STH7702/30

1,0m	364lx	60cm
2,0m	91lx	120cm
3,0m	40lx	180cm
4,0m	23lx	240cm
5,0m	15lx	300cm

Altura, Emax e Diâmetro

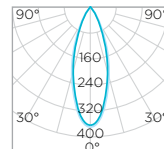

— C0/180 — C90/270

STH9720/30

1,0m	1055lx	40cm
2,0m	264lx	90cm
3,0m	117lx	130cm
4,0m	66lx	170cm
5,0m	42lx	210cm

Altura, Emax e Diâmetro

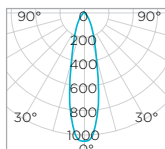

— C0/180 — C90/270

STH7701/30

1,0m	1689lx	40cm
2,0m	422lx	90cm
3,0m	188lx	130cm
4,0m	106lx	170cm
5,0m	68lx	210cm

Altura, Emax e Diâmetro

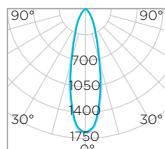

— C0/180 — C90/270

STH7703/30

1,0m	1689lx	40cm
2,0m	422lx	90cm
3,0m	188lx	130cm
4,0m	106lx	170cm
5,0m	68lx	210cm

Altura, Emax e Diâmetro

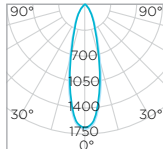

— C0/180 — C90/270

STH6080/27

1,0m	597lx	100cm
2,0m	149lx	190cm
3,0m	66lx	290cm
4,0m	37lx	390cm
5,0m	24lx	490cm

Altura, Emax e Diâmetro

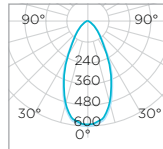

— C0/180 — C90/270

STH8716/30

1,0m	2156lx	30cm
2,0m	539lx	50cm
3,0m	240lx	80cm
4,0m	135lx	110cm
5,0m	86lx	130cm

Altura, Emax e Diâmetro

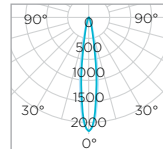

— C0/180 — C90/270

STH8717/30

1,0m	5932lx	20cm
2,0m	1483lx	50cm
3,0m	659lx	70cm
4,0m	371lx	100cm
5,0m	237lx	120cm

Altura, Emax e Diâmetro

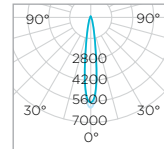

— C0/180 — C90/270

STH8719/30

STH8706/30

STH7706/30

1,0m	9462lx	30cm
2,0m	2366lx	50cm
3,0m	1051lx	80cm
4,0m	591lx	100cm
5,0m	378lx	130cm

Altura, Emax e Diâmetro

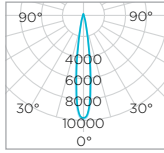

— C0/180 — C90/270

1,0m	1092lx	40cm
2,0m	273lx	90cm
3,0m	121lx	130cm
4,0m	68lx	170cm
5,0m	44lx	220cm

Altura, Emax e Diâmetro

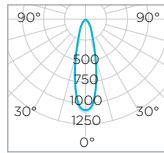

— C0/180 — C90/270

1,0m	1092lx	40cm
2,0m	273lx	90cm
3,0m	121lx	130cm
4,0m	68lx	170cm
5,0m	44lx	220cm

Altura, Emax e Diâmetro

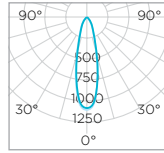

— C0/180 — C90/270

STH8707/30

STH7707/30

STH8708/30

1,0m	1789lx	60cm
2,0m	447lx	110cm
3,0m	199lx	170cm
4,0m	112lx	220cm
5,0m	72lx	280cm

Altura, Emax e Diâmetro

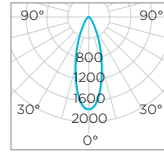

— C0/180 — C90/270

1,0m	1789lx	60cm
2,0m	447lx	110cm
3,0m	199lx	170cm
4,0m	112lx	220cm
5,0m	72lx	280cm

Altura, Emax e Diâmetro

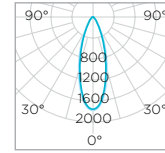

— C0/180 — C90/270

1,0m	1789lx	60cm
2,0m	447lx	110cm
3,0m	199lx	170cm
4,0m	112lx	220cm
5,0m	72lx	280cm

Altura, Emax e Diâmetro

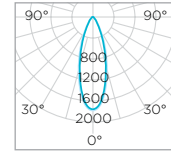

— C0/180 — C90/270

STH7708/30

STH8709/30

1,0m	1789lx	60cm
2,0m	447lx	110cm
3,0m	199lx	170cm
4,0m	112lx	220cm
5,0m	72lx	280cm

Altura, Emax e Diâmetro

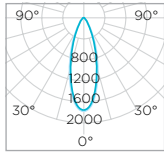

— C0/180 — C90/270

1,0m	2588lx	60cm
2,0m	647lx	130cm
3,0m	288lx	190cm
4,0m	162lx	260cm
5,0m	104lx	320cm

Altura, Emax e Diâmetro

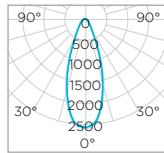

— C0/180 — C90/270

TRILHOS

SD1800BR/30
SD1800PTO/30

SD1805BR/30
SD1805PTO/30

SD1810BR/30
SD1810PTO/30

1,0m	668lx	61cm
2,0m	167lx	122cm
3,0m	74lx	183cm
4,0m	41lx	244cm
5,0m	26lx	306cm

Altura, Emax e Diâmetro

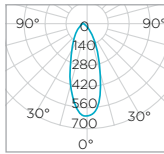

— C0/180 — C90/270

1,0m	1317lx	68cm
2,0m	329lx	136cm
3,0m	146lx	205cm
4,0m	82lx	273cm
5,0m	52lx	342cm

Altura, Emax e Diâmetro

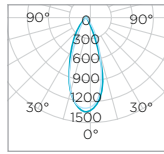

— C0/180 — C90/270

1,0m	2863lx	68cm
2,0m	715lx	136cm
3,0m	318lx	205cm
4,0m	178lx	273cm
5,0m	114lx	342cm

Altura, Emax e Diâmetro

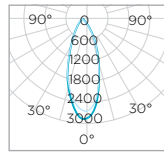

— C0/180 — C90/270

GRÁFICOS DE EFEITOS

O distanciamento das luminárias Square pode ser baseado na altura desejada do efeito.

SQUARE

O Square é um embutido recuado direcionável de grande versatilidade, próprio para diversos ambientes, tanto residenciais quanto comerciais. As medidas descritas são baseadas na orientação em 15° da lâmpada para a parede.

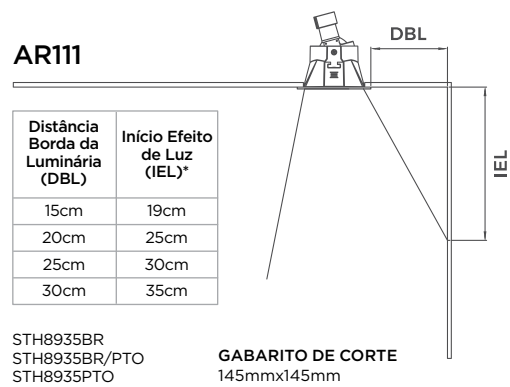
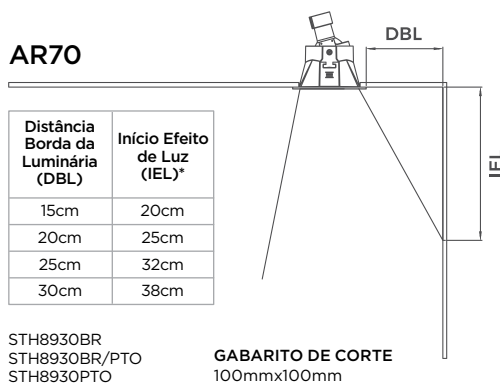
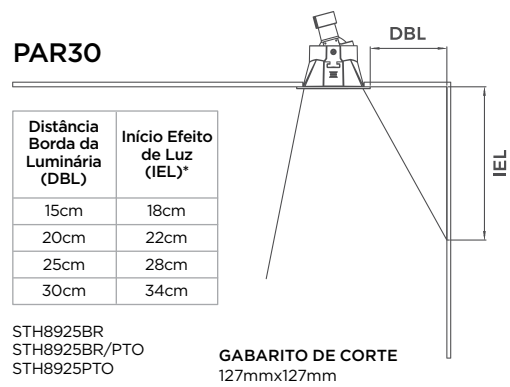
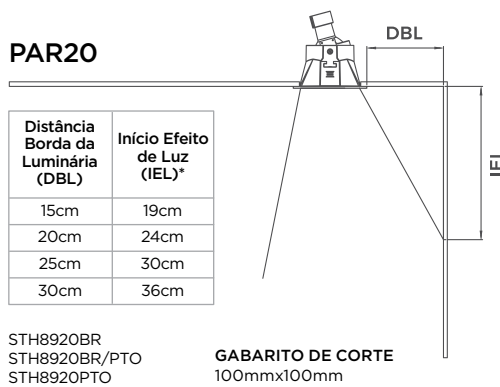
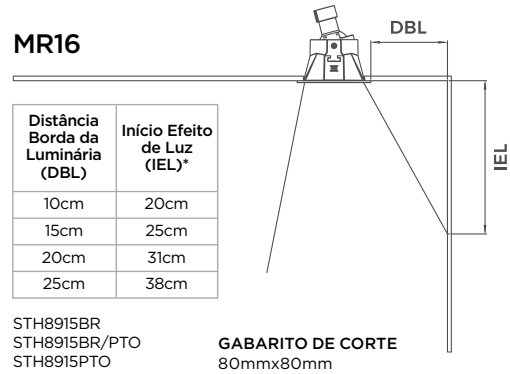
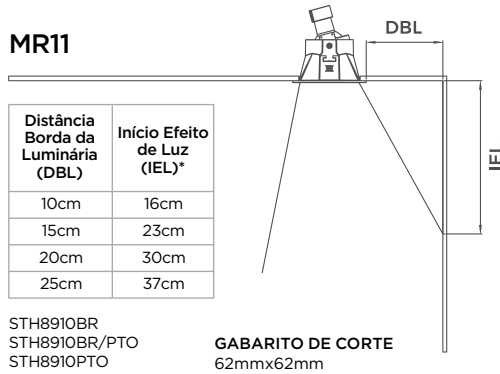

*Efeito calculado com base no uso de lâmpadas EVO da linha PRO Stella.



SQUARE GHOST

Dica de uso: as luminárias Square Ghost podem ser usadas em qualquer ambiente onde se busca uma iluminação cênica com mínimo ofuscamento. As medidas descritas são baseadas na orientação em 15° da lâmpada para a parede.

MR11

Distância Borda da Luminária (DBL)	Início Efeito de Luz (IEL)*
10cm	26cm
15cm	39cm

STH8940BR
STH8940BR/PTO
STH8940PTO

GABARITO DE CORTE
60mmx60mm

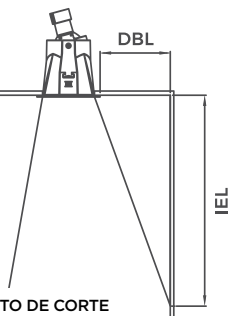

MR16

Distância Borda da Luminária (DBL)	Início Efeito de Luz (IEL)*
10cm	22cm
15cm	33cm

STH8945BR
STH8945BR/PTO
STH8945PTO

GABARITO DE CORTE
79mmx79mm

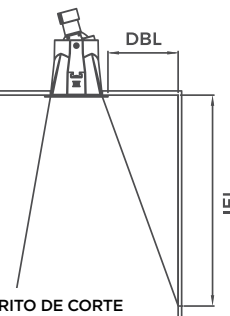

PAR20

Distância Borda da Luminária (DBL)	Início Efeito de Luz (IEL)*
10cm	22cm
15cm	32cm

STH8950BR
STH8950BR/PTO
STH8950PTO

GABARITO DE CORTE
99mmx99mm

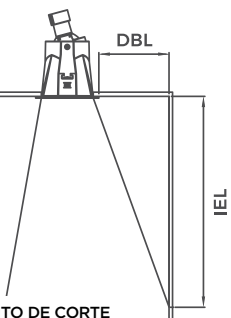

AR70

Distância Borda da Luminária (DBL)	Início Efeito de Luz (IEL)*
10cm	16cm
15cm	27cm

STH8955BR
STH8955BR/PTO
STH8955PTO

GABARITO DE CORTE
99mmx99mm

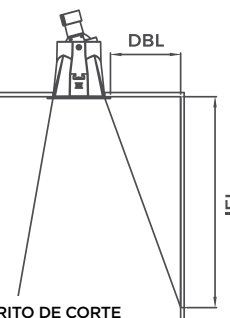

SQUARE ANGLE

Dica de uso: as luminárias Square Angle possibilitam uma variedade de aplicações. A fonte luminosa angulada permite que os embutidos sejam instalados a distâncias maiores da parede ou do objeto que se pretende iluminar. Com esse distanciamento ampliado, é possível iluminar objetos de forma mais frontal, com índice de sombreamento muito menor e luz mais homogênea.

MR11 25°

Distância Borda da Luminária (DBL)	Início Efeito de Luz (IEL)*
15cm	15cm
20cm	19cm
25cm	23cm
30cm	28cm
40cm	38cm
60cm	56cm
80cm	73cm
100cm	97cm

STH8960BR
STH8960BR/PTO
STH8960PTO

GABARITO DE CORTE
60mmx60mm

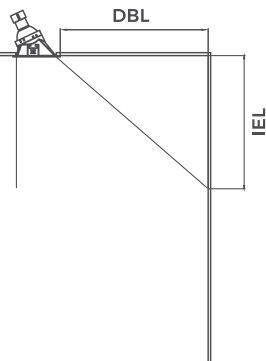

MR16 25°

Distância Borda da Luminária (DBL)	Início Efeito de Luz (IEL)*
15cm	15cm
20cm	18cm
25cm	22cm
30cm	27cm
40cm	36cm
60cm	54cm
80cm	74cm
100cm	90cm

STH8970BR
STH8970BR/PTO
STH8970PTO

GABARITO DE CORTE
80mmx80mm

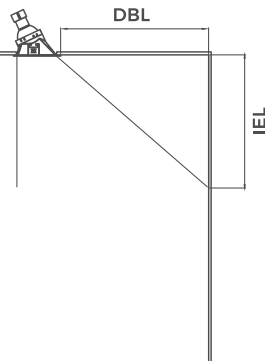

MR11 40°

Distância Borda da Luminária (DBL)	Início Efeito de Luz (IEL)*
20cm	12cm
30cm	16cm
40cm	22cm
50cm	28cm
60cm	33cm
70cm	39cm
80cm	46cm
100cm	56cm
125cm	70cm
150cm	82cm

STH8965BR
STH8965BR/PTO
STH8965PTO

GABARITO DE CORTE
60mmx90mm

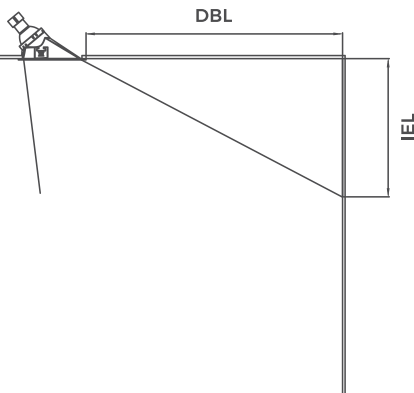

MR16 40°

Distância Borda da Luminária (DBL)	Início Efeito de Luz (IEL)*
20cm	11cm
30cm	16cm
40cm	21cm
50cm	27cm
60cm	32cm
70cm	38cm
80cm	45cm
100cm	54cm
125cm	66cm
150cm	80cm

STH8975BR
STH8975BR/PTO
STH8975PTO

GABARITO DE CORTE
80mmx116mm

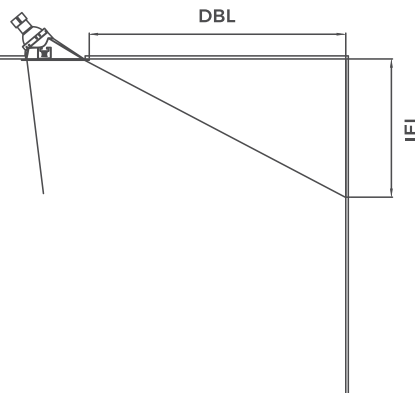

*Efeito calculado com base no uso de lâmpadas EVO da linha PRO Stella.

CONCEITOS LUMINOTÉCNICOS

132 FLUXO LUMINOSO

INTENSIDADE LUMINOSA

EFICIÊNCIA LUMINOSA

ÍNDICE DE REPRODUÇÃO DE COR (IRC)

TEMPERATURA DE COR

INFORMAÇÕES TÉCNICAS

133 VIDA ÚTIL

BASE

GRAU DE PROTEÇÃO



CONCEITOS LUMINOTÉCNICOS

Fluxo luminoso

Unidade de medida: lúmen (lm).

Refere-se à quantidade total de luz emitida por uma fonte luminosa.

Intensidade luminosa

Unidade de medida: candela (cd).

Refere-se à quantidade de luz projetada em uma determinada direção. Esta medida é importante para luminárias ou lâmpadas com fecho de luz do tipo direcional e é diretamente influenciada pelo ângulo de abertura do fecho da fonte luminosa. Quando comparadas duas fontes de luz de mesmo fluxo luminoso, quanto menor o ângulo de abertura, maior a intensidade da luz.

Eficiência luminosa

Unidade de medida: lumens/watt (lm/W).

É a relação entre a quantidade total de luz e a potência consumida. Quanto mais eficiente uma lâmpada é, maior a quantidade de lumens gerada em relação a cada watt de potência consumida.

Índice de Reprodução de Cor (IRC)

Indica o grau de fidelidade com que as cores são reproduzidas por uma determinada fonte de luz. Um índice de reprodução 100 (dado à luz solar) apresenta as cores com total fidelidade e precisão. Quanto menor o valor, menor a eficiência da fonte de luz em reproduzir cores.

Temperatura de cor

Unidade de medida: kelvin (K).

Indica a aparência da cor da luz. A “luz quente” é a que tem aparência branco-amarelada e temperatura de cor baixa, até 3.000K. A “luz neutra” apresenta cor branco-neutra e temperatura em torno de 4.000K. Já a “luz fria” tem aparência branco-fria, quase azulada, com temperatura de cor elevada, 5.000K ou mais. O gráfico abaixo demonstra a relação que existe entre a temperatura de cor em kelvin (K) e a cor que ela representa.

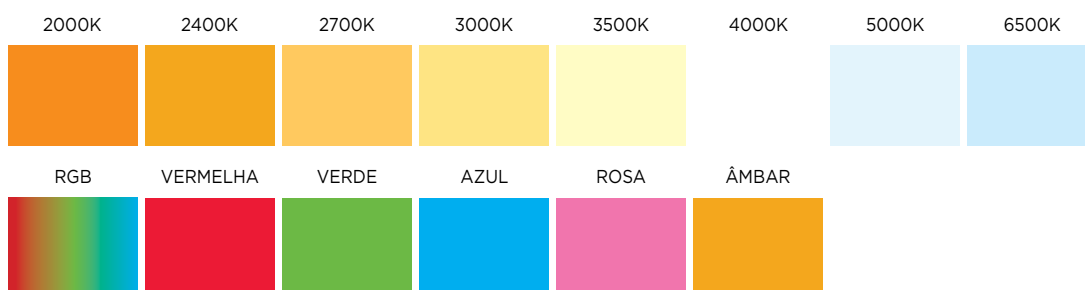

INFORMAÇÕES TÉCNICAS

Vida útil (L70)

Unidade de medida: horas (h).

É o número de horas que correspondem ao tempo em que uma lâmpada LED fornece 70% ou mais do fluxo luminoso inicial.

Base

A base tem como função a conexão elétrica do produto e sua fixação ao soquete da luminária. Veja as bases utilizadas nos produtos Stella:

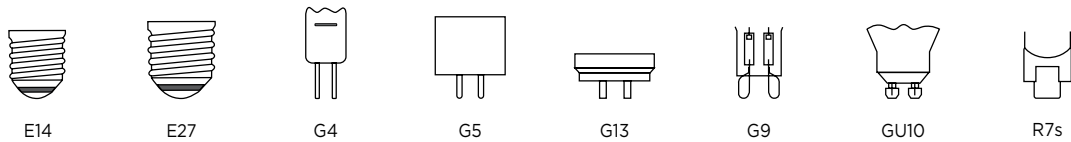

Grau de Proteção (IP)

O código IP (do inglês International Protection Rating) - ou Grau de Proteção - classifica os níveis de proteção do invólucro do produto contra objetos sólidos (poeira, dedos, mãos, etc.) e líquidos. É representado por dois dígitos: o primeiro indica o grau de proteção contra objetos sólidos e o segundo, contra líquidos.

PROTEÇÃO CONTRA SÓLIDOS

0		Sem proteção
1		Proteção contra corpos estranhos sólidos com 50 mm de diâmetro ou maiores
2		Proteção contra corpos estranhos sólidos com 12,5mm de diâmetro ou maiores
3		Proteção contra corpos estranhos sólidos com 2,5mm de diâmetro ou maiores
4		Proteção contra corpos estranhos sólidos com 1mm de diâmetro ou maiores
5		Proteção contra acumulação de pó
6		Proteção contra penetração de pó

PROTEÇÃO CONTRA ÁGUA

0		Nenhuma proteção
1		Proteção contra gotejamento na vertical
2		Proteção contra gotejamento oblíquo (inclinação de até 15°)
3		Proteção contra borrifos de água (inclinação de até 60°)
4		Proteção contra salpicos de água
5		Proteção contra jatos de água
6		Proteção contra jatos fortes de água
7		Proteção contra efeitos da submersão na água por algum tempo
8		Proteção contra efeitos da submersão na água por tempo prolongado

Veja um exemplo:

IP 6 7



J. NORBERTO REPR. COM. LTDA

ILUMINAÇÃO

Av. Pedro Zapelini, 1119 - Centro

Fone/Fax (48) 3622-5568 - (48) 99986-2613

E-mail: jnorberto@jnorberto.com.br - www.jnorberto.com.br

88701-480 - Tubarão - Santa Catarina

STELLA

IDEIAS LUMINOSAS