



catálogo
SULIGHT 2019

SUMÁRIO

Ball.....	01
Torch.....	04
Lamp.....	07
Movement.....	12
Tube.....	18
Form.....	20
Industrial.....	24
Hat.....	28
Antique.....	32
Tabela de cores.....	35



LINHA BALL





Ref.: 313/A
 Descrição: Arandela
 1 bola diam.
 15cm
 Lâmpadas: 3 x E-27
 CxLxH: 25x15x65 cm

Ref.: 315/3-AR
 Descrição: Arandela 3
 bolas diam.
 15cm
 Lâmpadas: 3 x E-27
 CxLxH: 38x12x20 cm

Ref.: 315/4-H
 Descrição: Pafion 4
 bolas diam.
 15cm
 Lâmpadas: 4 x E-27
 CxLxH: 75x32x20 cm

Ref.: 315/5
 Descrição: Pendente
 5 bolas diam.
 15cm
 Lâmpadas: 5 x E-27
 CxLxH: 110x32x115 cm

315/A



315/TETO



315/AR

1509/H70



1509

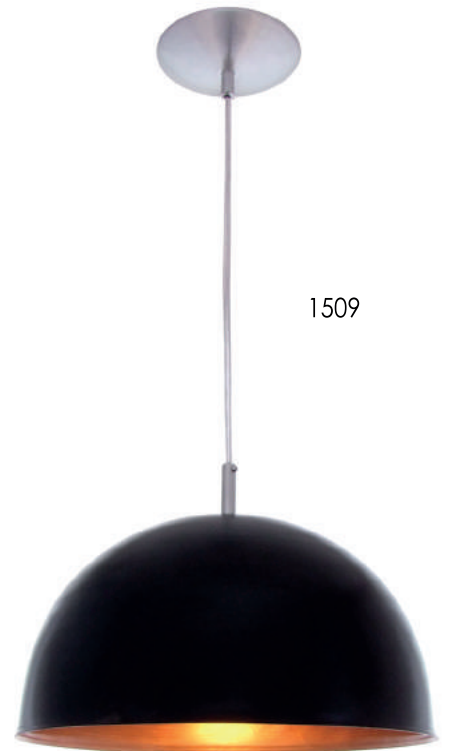

Ref.: 315/A
 Descrição: Arandela "L"
 bola diam.
 15cm
 Lâmpadas: 1 x E-27
 CxLxH: 19x15x18 cm

Ref.: 315/AR
 Descrição: Arandela 1
 bola diam.
 15cm
 Lâmpadas: 1 x E-27
 CxLxH: 20x13x24 cm

Ref.: 315/TETO
 Descrição: Spot com
 bola 15cm
 Lâmpadas: 1 x E-27
 CxLxH: 110x19x15 cm

Ref.: 1509/H70
 Descrição: Arandela
 haste móvel
 70 cm. Cúpula
 33 cm.
 Lâmpadas: 1 x E-27
 CxLxH: 90x60x33

Ref.: 1509
 Descrição: Pendente
 cúp. 1/2
 esfera diâm.
 33 cm.
 Lâmpadas: 1 x E-27
 CxLxH: Diâm 33x106 cm.

1509/B10-AR

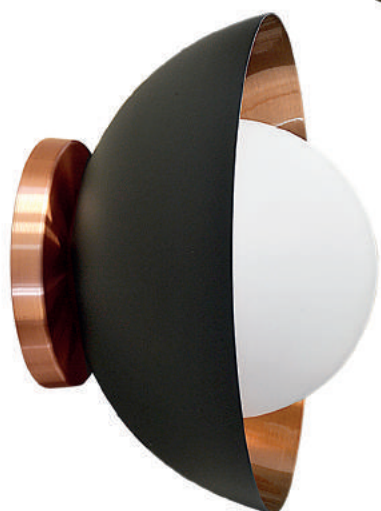

1509/B15-AR

1513/14



1513/14-U

1509/50

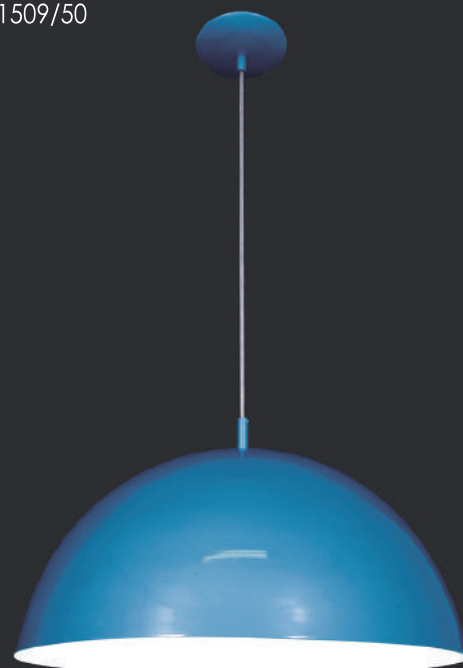

Ref.: 1513/14
 Descrição: Pendente
 bola alumínio
 14cm.
 Lâmpadas: 1 x E-27
 CxLxH: Diâm.
 14x124cm

Ref.: 1509/B10-AR
 Descrição: Arandela
 meia esfera
 20 cm e bola
 10 cm
 Lâmpadas: 1 x halopin
 CxLxH: Diâm.
 20x12 cm

Ref.: 1509/B15-AR
 Descrição: Arandela
 meia esfera
 25 cm e bola
 15 cm
 Lâmpadas: 1 x E-27
 CxLxH: Diâm.
 25x17 cm

Ref.: 1513/14-U
 Descrição: Pendente
 bola alum.
 14 cm - Alça
 direcionável
 Lâmpadas: 1 x E-27
 CxLxH: 15x17x115 cm

Ref.: 1509/50
 Descrição: Pendente
 1/2 esfera
 diâm.
 50cm.
 Lâmpadas: 1 x E-27
 CxLxH: Diâm 50x125 cm



LINHA TORCH

AMBIENTE: ALEXANDRE VOIGT / FOTO: JAMES (DEEHOUSE)



1635



1638



1635/30-RET



1635/R



1636

Ref.: 1635

Descrição: Arandela
cúpula diâm.
17x24 cm.

Lâmpadas: 1 x E-27
CxLxH: 17x22x80cm.

Ref.: 1638

Descrição: Lustre 4 hastas
45 cm. cúp.
Diâm. 17x24cm.

Lâmpadas: 4 x E-27
CxLxH: 50x220cm.

Ref.: 1635/30 RET

Descrição: Arandela
cúpula diâm.
17x24 cm.

Lâmpadas: 1 x E-27
CxLxH: 40x14x20cm.

Ref.: 1635-R

Descrição: Arandela
cúpula diâm.
17x24 cm.

Lâmpadas: 1 x E-27
CxLxH: 17x22x60cm.

Ref.: 1636

Descrição: Arandela
cúpula diâm.
17x24 cm.

Lâmpadas: 1 x E-27
CxLxH: 17x22x40cm.



1637



1894



1639/100



2017



1635/20-Q

Ref.: 1637
 Descrição: Arandela
 cúpula diâm.
 12x10 cm.
 Lâmpadas: 1 x Halopin
 CxLxH: 15x9x30cm

Ref.: 2017
 Descrição: Arandela
 cúpula diâm.
 17x23 cm.
 Lâmpadas: 1 x E-27
 CxLxH: 60x30x20 cm.

Ref.: 1635/20-Q
 Descrição: Arandela
 cúpula diâm.
 17x24 cm.
 Lâmpadas: 1 x E-27
 CxLxH: 40x17x21 cm.

Ref.: 1639/100
 Descrição: Arandela
 haste 1m. cúp.
 17x24 cm.
 Lâmpadas: 1 x E-27
 CxLxH: 119x13x17 cm.

Ref.: 1894
 Descrição: 2 braços
 com cúpula
 Lâmpadas: 2 x E-27
 CxLxH: 34x47x14cm.

A modern interior scene featuring a blue cabinet, a wooden wall, and a lamp with three Edison bulbs. The scene is set in a room with wood-paneled walls. A blue cabinet with three drawers is in the foreground. On top of the cabinet is a dark wooden shelf. On the shelf, there is a small lamp with a glowing yellow light, a vase with green plants, and two small black figurines. To the right, a wall-mounted lamp with three Edison bulbs is illuminated. A framed abstract artwork is on the wall. In the bottom right corner, a portion of a chair with a white patterned backrest is visible.

LINHA LAMP

AMBIENTE: ARQ. BARBARA LEHMKUHL / FOTO: FERNANDO WILLADINO

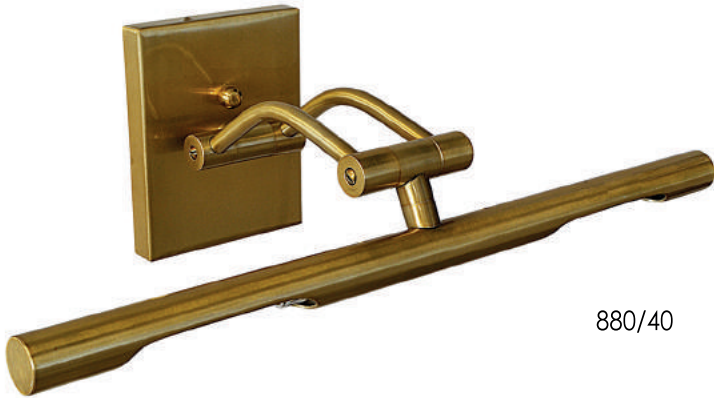

880/40

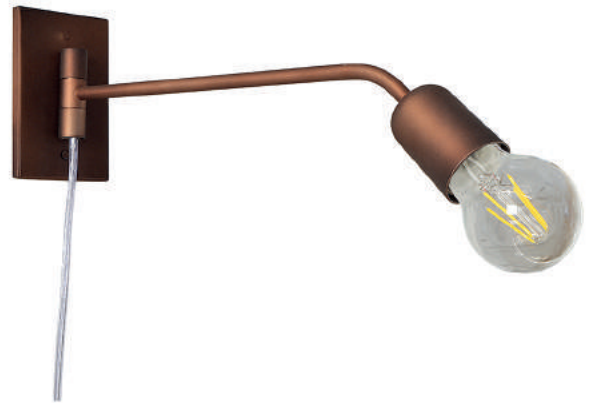

1544



1544/2



1911



1544/3

Ref.: 880/4
 Descrição: Arandela articulável para quadro.
 Lâmpadas: 2 x Halopin
 CxLxH: 17x40x8cm.

Ref.: 1544
 Descrição: Arandela articulada fio externo.
 Lâmpadas: 1 x E-27
 CxLxH: 30x12 cm.

Ref.: 1544/2
 Descrição: Arandela 2 hastes articuláveis
 Lâmpadas: 2 x E-27
 CxLxH: 42x12 cm.

Ref.: 1544/3
 Descrição: Arandela 3 hastes articuláveis.
 Lâmpadas: 3 x E-27
 CxLxH: 35x9x19 cm.

Ref.: 1911
 Descrição: Fio PP e cabo e suporte.
 Lâmpadas: 1 x E-27

1913



1914



1991/5

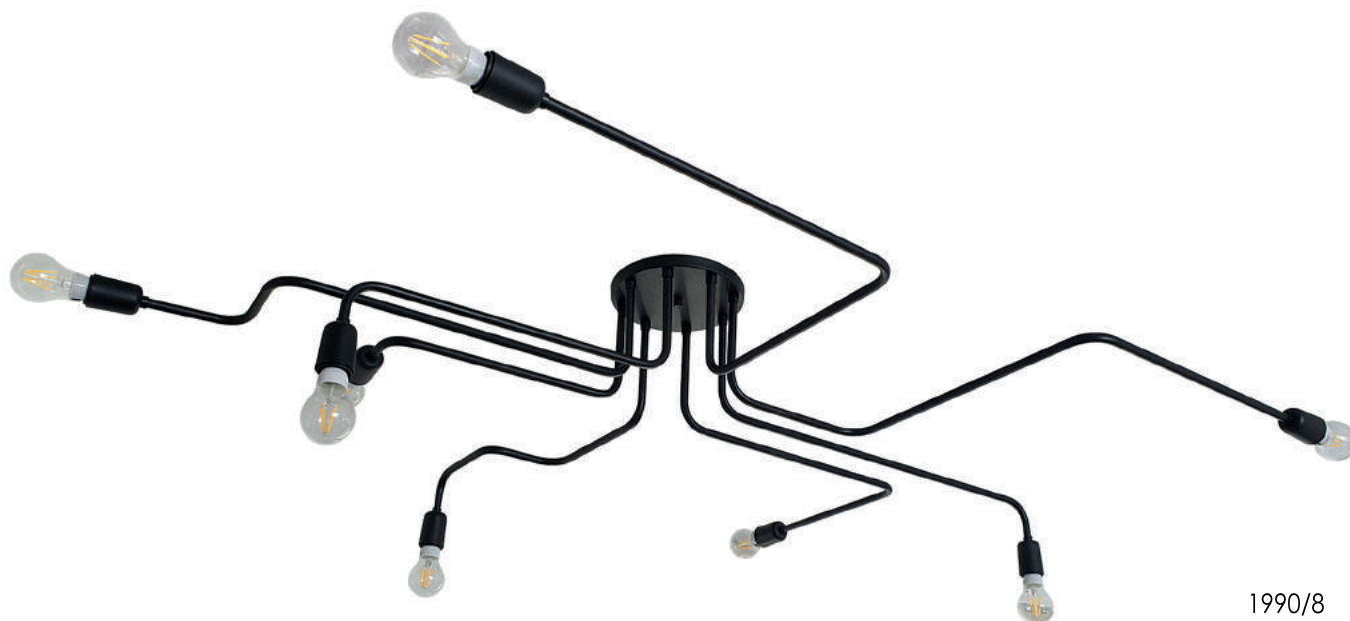

1990/8

Ref.: 1913

Descrição: Pendente,
fio PP e cabo.

Lâmpadas: 1 x E27
CxLxH: 4x4x104cm.

Ref.: 1914

Descrição: Fio PP e
proteção de
lâmpada

Lâmpadas: 1 x E-27
CxLxH: Diâm.
13x110 cm.

Ref.: 1991/5

Descrição: Arandela saída
de fio externa.

Lâmpadas: 5x E-27
CxLxH: 80x30x8 cm.

Ref.: 1990/8 plafon

Descrição: Encanamento
8 braços.

Lâmpadas: 8 x E-27
CxLxH: 120x60 cm.



1916



1916/H



1995/6



1993/4



1994/5

Ref.: 1993/4
 Descrição: Pendente
 com tubo
 de 1'x1/2" x
 35cm.
 Lâmpadas: 4 x E-27
 CxLxH: Diâm.
 16x135 cm.

Ref.: 1994/5
 Descrição: Paflon
 5 tubos.
 Lâmpadas: 5 x E-27
 CxLxH: 60x40x17 cm.

Ref.: 1995/6
 Descrição: Pendente
 hastes fixas
 Lâmpadas: 6 x E-27
 CxLxH: 120x90x130 cm.

Ref.: 1916
 Descrição: Arandela,
 fio PP e
 suporte de
 lâmpada
 Lâmpadas: 1 x E-27
 CxLxH: 10x13 cm.

Ref.: 1916-H
 Descrição: Arandela,
 fio PP sup.
 de lâmpada
 Lâmpadas: 1 x E-27
 CxLxH: 21x9x8 cm.



2002



2025/BC

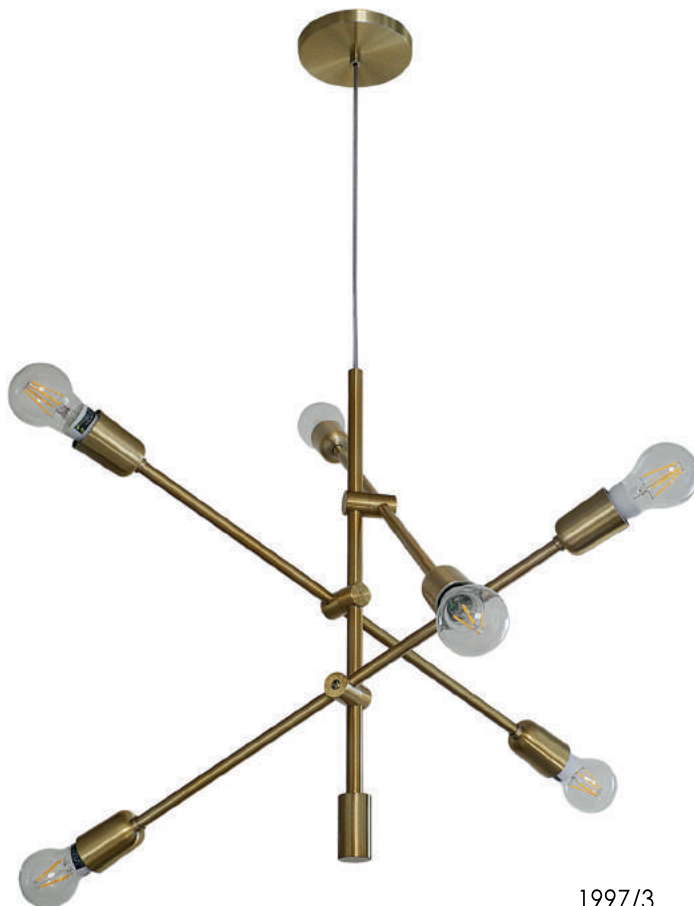

1997/3

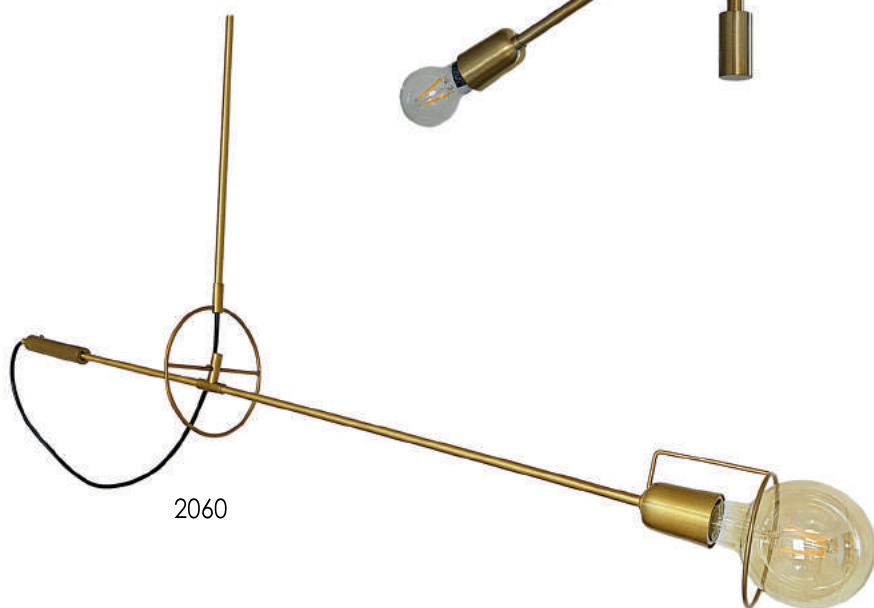

2060

Ref.: 2002

Descrição: Arandela disco
diâm. 25 cm.Lâmpadas: 1 x E27
CxLxH: 33x25x8 cm.

Ref.: 2025/BC

Descrição: Coluna
bocal com
proteção
lâmpada.Lâmpadas: 1 x E-27
CxLxH: 110x28x140 cm.

Ref.: 2060

Descrição: Pendente
vara com
proteção no
vocal.Lâmpadas: 1 x E-27
CxLxH: 90x110cm.

Ref.: 1997/3

Descrição: Pendente
3 hastes
regul. com
2 lâmpadasLâmpadas: 6 x E-27
CxLxH: 63x150 cm.



LINHA MOVEMENT

AMBIENTE: STACH BORDIGNOM ARQUITETURA - ESPAÇO CASA COR SC 2018

1511/14-ST4



1516/ST6



1516/H10-AT



Ref.: 1511/14-ST4
 Descrição: Pendente,
 cúpula
 articulada e
 trave.
 Lâmpadas: 4 x E27
 CxLxH: 34x90x35 cm.

Ref.: 1516/H10-AT
 Descrição: Pendente
 10 braços.
 Cone diam.
 11cm.
 Lâmpadas: 10 x E-27
 CxLxH: Diâm. 90cm.

Ref.: 1516/ST6
 Descrição: Pendente
 trave com 6
 cup. diam.
 14x33cm.
 Lâmpadas: 6 x E-27
 CxLxH: 135x30x128cm.



1533



1516



1538

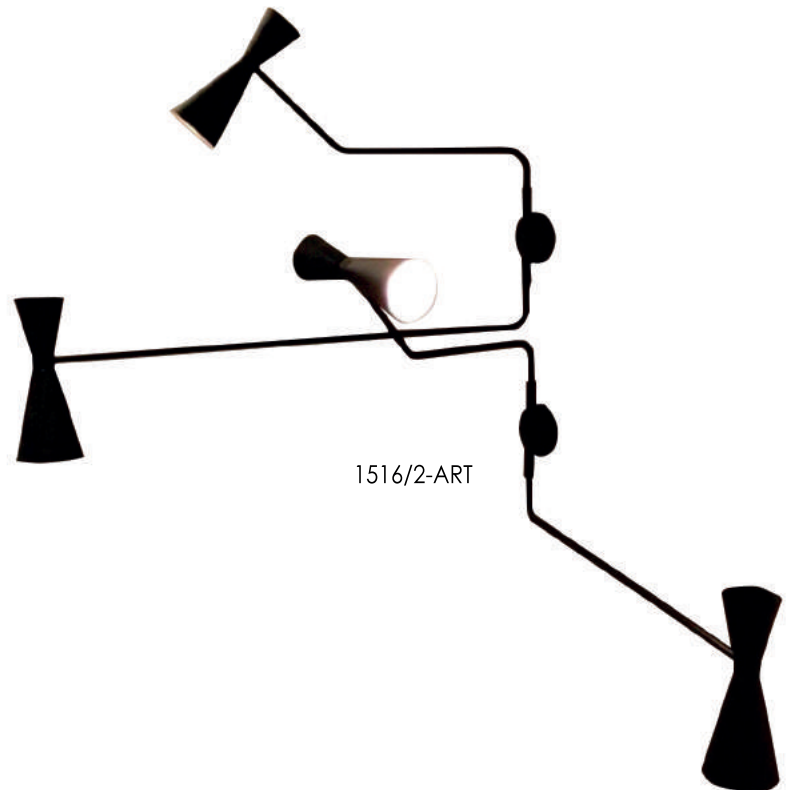

1516/2-ART

Ref.: 1538
 Descrição: Spot articulado
 cúp. diâm.
 15x17 cm.
 Lâmpadas: 1 x E-27
 CxLxH: Diâm.
 15x125 cm.

Ref.: 1533
 Descrição: Arandela
 cúpula diâm.
 17x17 cm
 Lâmpadas: 1 x E-27
 CxLxH: Diâm.
 17x90cm.

Ref.: 1516
 Descrição: Pendente
 cone duplo
 diâm.
 14 x 33 cm.
 Lâmpadas: 1 x E-27
 CxLxH: Diâm.
 14x137cm.

Ref.: 1516/2-ART
 Descrição: Arandela
 2 braços
 articulável
 Lâmpadas: 2 x E-27
 CxLxH: 210x25x115 cm.



Ref.: 1534
 Descrição: Arandela
 haste e cúpula
 cone diam.
 18 cm.
 Lâmpadas: 1 x E27
 CxLxH: 60x18x30 cm.

Ref.: 1531/2
 Descrição: Arandela
 com braços
 articuláveis.
 Lâmpadas: 2 x E-27
 CxLxH: 210x25x115cm.

Ref.: 1608/H70
 Descrição: Arandela
 haste móvel
 70 cm cúp.
 34 cm diâm.
 Lâmpadas: 1 x E-27
 CxLxH: 90x60x34cm.

LINHA TUBE



AMBIENTE: GM ARQUITETURA / FOTO: DENNYS MANSKE

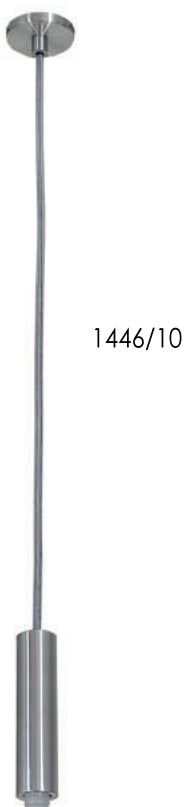

Ref.: 1445/15

1445/30

1445/50

Descrição: Pendente 1 tubo 2" canopla redonda.

Lâmpadas: 1 x minidicroica

CxLxH: 5x(15 cm).
5x(30 cm).
5x(50 cm).

Ref.: 1446/10

Descrição: Pendente tubo 1" x 10 cm.

Lâmpadas: 1 x halopin/led
CxLxH: Diâm. 2,5x110 cm

Ref.: 1446/30

Descrição: Pendente tubo 1" x 30 cm.

Lâmpadas: 1 x halopin/led
CxLxH: Diâm. 2,5x130 cm.

Ref.: 1446/50

Descrição: Pendente tubo 1" x 50 cm.

Lâmpadas: 1 x halopin/led
CxLxH: Diâm. 2,5x150 cm

Ref.: 1446/10-R3

1446/30-R3

1446/50-R3

Descrição: Pendente 3 tubo 1"

Lâmpadas: 3 x halopin/led
CxLxH: 2,5x110cm
2,5x130cm
2,5x150cm

Ref.: 1449/40-BC

Descrição: Pendente tubo 1" x 1/2"

Lâmpadas: 1 x halopin
CxLxH: Diâm. 3,8x140 cm.

LINHA **TUBE**

1446/30-PR

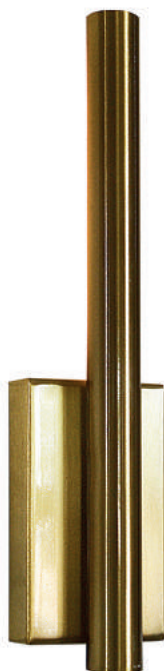

1446/30-PR-FL



1905



1449/30-LT6

Ref.: 1446/30-PR-FL
1446/50-PR-FL
1446/100-PR-FL

Descrição: Arandela
tubo 1"
30 cm.

Lâmpadas: Fita led
CxLxH: 30x3, 5x9 cm.
50x3, 5x9 cm.
100x3, 5x9 cm.

Ref.: 1446/15-PR

1446/30-PR
1446/50-PR

Descrição: Arandela
tubo 1"
iluminação
dupla

Lâmpadas: 2 x halopin
CxLxH: 4x10x15 cm.
4x10x30 cm.
4x10x50 cm.

Ref.: 1449/30-LT6

Descrição: Pendente
com 6 tubos
de 1' 1/2"

Lâmpadas: 6 x mini
dicróica

CxLxH: Diâm.
60x156 cm.

Ref.: 1905

Descrição: Coluna
tripé
tubular.
Cúpula diâm.
50x160 cm.

Lâmpadas: 2 x E-27
CxLxH: Diâm
50x160 cm.



2056/3



2056/AR



2056/C

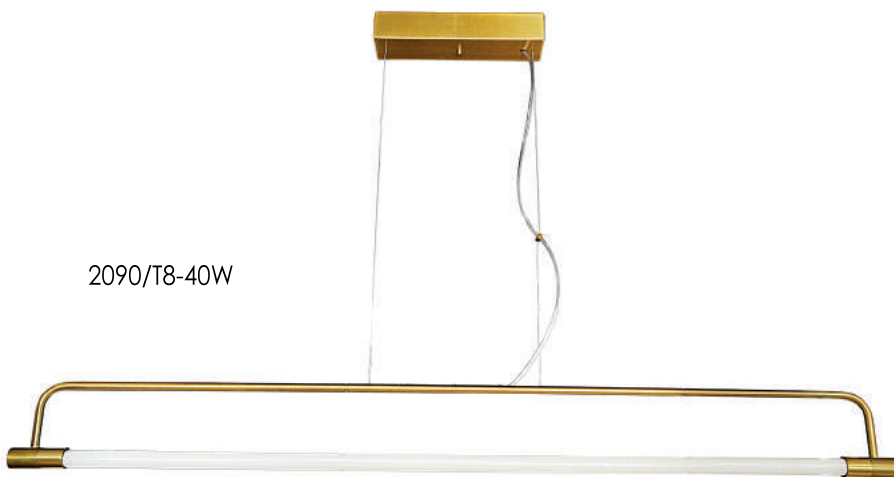

2090/T8-40W

Ref.: 2056/3
 Descrição: Spot com haste fixa.
 3 tubos
 1' 1/2" x 22 cm.
 Lâmpadas: 3 x halopin/
 mini-dicr.
 CxLxH: 110x30 cm.

Ref.: 2056/AR
 Descrição: Arandela articulada
 tubo 1' 1/2"
 Lâmpadas: 1 x MR-11
 CxLxH: 35x12x32 cm.

Ref.: 2090/T8-40W
 Descrição: Pendente
 lâmpada fluor.
 led.
 Lâmpadas: 1 x T8-40w LED
 CxLxH: 130x12x115 cm.

Ref.: 2056/C
 Descrição: Coluna articulável.
 Lâmpadas: 1 x mini
 dicroica
 CxLxH: 23x14x160 cm.



LINHA FORM

1612



1612/P



1612/A



1694/20



1694/15



1694



Ref.: 1612

Descrição: Pendente cone ornamentado.
Diam. 18x44 cm.
Lâmpadas: 1 x E-27
CxLxH: Diâm. 18x144 cm.

Ref.: 1612/A

Descrição: Arandela cone diam. 18x44 cm.
Lâmpadas: 1 x E-27
CxLxH: Diâm. 18x53 cm.

Ref.: 1612/P

Descrição: Pendente cone ornamentado 18 cm.
Lâmpadas: 1 x E-27
CxLxH: 18x35 cm.

Ref.: 1694

Descrição: Arandela 5 camadas
Lâmpadas: 2 x halopin
CxLxH: 28x25x12 cm.

Ref.: 1694/15

Descrição: Arandela iluminação sup/inf/central
Lâmpadas: 1 x halopin
CxLxH: 16x09x07 cm.

Ref.: 1694/20

Descrição: Arandela iluminação sup/inf/central
Lâmpadas: 1 x E-27
CxLxH: 20x12x09 cm.



1615

1615/T4

1615/A

Ref.: 1615/T4

Descrição: Pendente trave
com 4 cúpulas
diam. 14x14 cm.

Lâmpadas: 4 x E-27
CxLxH: 108x17x117 cm.

Ref.: 1615

Descrição: Pendente
cúpula diâm.
15x17 cm.

Lâmpadas: 1 x E-27
CxLxH: 15x110 cm.

Ref.: 1615/A

Descrição: Arandela
cúpula diâm.
14x14 cm.

Lâmpadas: 1 x E-27
CxLxH: 30x30 cm.

2000/25



1950

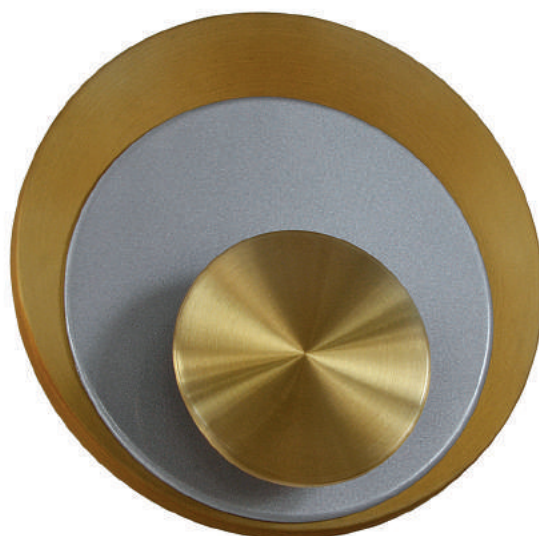

2015

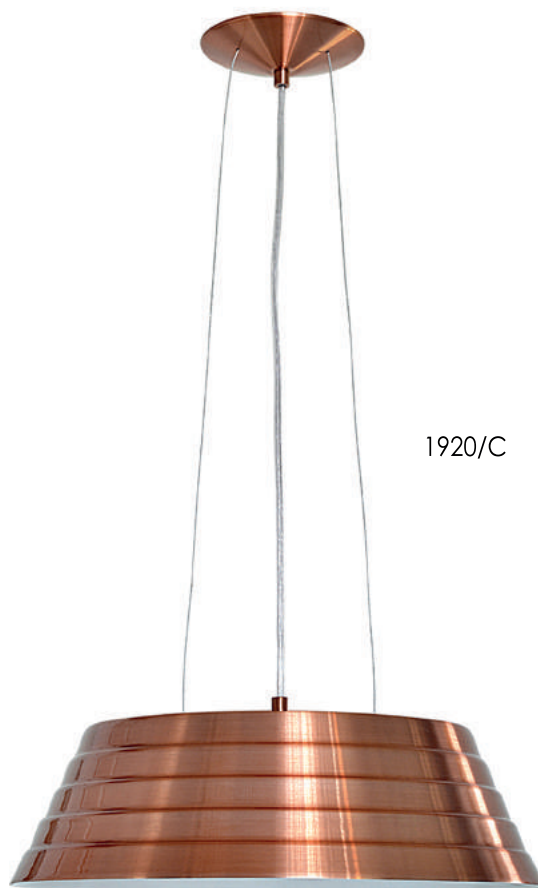

1920/C

Ref.: 1950

Descrição: Arandela luz indireta - difusor acrílico.

Lâmpadas: 1 x halopin
CxLxH: 23x12x5 cm.

Ref.: 2000/25

Descrição: Arandela disco diam. 25cm

Lâmpadas: 1 x halopin
CxLxH: 25x25x9 cm.

Ref.: 2015

Descrição: Arandela base L, cúpula diâm. 13x10 cm.

Lâmpadas: 1 x halopin
CxLxH: 16x13x15 cm.

Ref.: 1920/C

Descrição: Pendente cúpula diâm. 40x14 cm.

Lâmpadas: 1 x E-27
CxLxH: Diâm. 40x114 cm.

LINHA INDUSTRIAL



AMBIENTE: GOLDEN BARBER SHOP / FOTO: GGE DESIGN ESTÚDIO



Ref.: 1526/12
 Descrição: Pendente cúp.
 diâm. 12x20cm.
 Lâmpadas: 1 x E-27
 CxLxH: 12x120 cm.

Ref.: 1526/12-ART
 Descrição: Arandela
 articulada
 c/ cúp. diâm.
 12x20 cm.
 Lâmpadas: 1 x E-27
 CxLxH: 120x12x12 cm.

Ref.: 1526/20
 Descrição: Pendente cúp.
 diâm. 20x27cm.
 Lâmpadas: 1 x E-27
 CxLxH: Diâm.
 20x127 cm.

Ref.: 1526/30
 Descrição: Pendente cúp.
 diâm. 30x34cm.
 Lâmpadas: 1 x E-27
 CxLxH: Diâm.
 30x134 cm.

Ref.: 1532
 Descrição: Arandela
 cúp. diâm.
 20 x 10 cm.
 Lâmpadas: 1 x E-27
 CxLxH: 20x90 cm.



1528/25-A



1528/50-V



1528/25-V



1528/33-V



1527/30-V

Ref.: 1528/25-A
 Descrição: Arandela cúp.
 diâm. 25x30cm.
 Lâmpadas: 1 x E-27
 CxLxH: 40x35 cm.

Ref.: 1528/25-V
 Descrição: Pendente cúp.
 diâm. 25x27 cm.
 Lâmpadas: 1 x E-27
 CxLxH: Diâm.
 25x130 cm.

Ref.: 1528/50-V
 Descrição: Pendente cúp.
 diâm. 252x50cm.
 Lâmpadas: 3 x E-27
 CxLxH: Diâm.
 52x105 cm.

Ref.: 1528/33-V
 Descrição: Pendente cúp.
 diâm. 33x40cm.
 Lâmpadas: 1 x E-27
 CxLxH: Diâm.
 33x140 cm.

Ref.: 1527/12-V
 1527/20-V
 1527/30-V
 1527/45-V (2xE-27)
 Descrição: Pendente
 Lâmpadas: 1 x E-27
 CxLxH: Diâm. 12x120 cm.
 Diâm. 20x127 cm.
 Diâm. 20x130 cm.
 Diâm. 45x140 cm.



1537/20

1558/30



1535/20



1904/25

Ref.: 1537/20
 Descrição: Arandela cúp.
 diâm. 20x23cm.
 Lâmpadas: 1 x E-27
 CxLxH: Diâm.
 20x23 cm.

Ref.: 1535/20
 Descrição: Pendente cúp.
 diâm. 20x23cm.
 Lâmpadas: 1 x E-27
 CxLxH: Diâm.
 20x123 cm.

Ref.: 1558/20
 1558/30
 Descrição: Pendente
 industrial
 Lâmpadas: 1 x E-27
 CxLxH: Diâm.
 20x135 cm.
 30x150 cm.

Ref.: 1904/25
 Descrição: Coluna tripé
 cúp. diâm.
 25x27 cm.
 Lâmpadas: 1 x E-27
 CxLxH: 50x160 cm.



LINHA HAT

1507/GR



1608/A



1609/18-A



1609/18-AT2



Ref.: 1507/GR
 Descrição: Pendente
 cúp. diâm.
 47 cm.
 Lâmpadas: 1 x E-27
 CxLxH: 47x47x142 cm.

Ref.: 1608/A
 Descrição: Arandela
 cúp. diâm.
 34 cm.
 Lâmpadas: 1 x E-27
 CxLxH: 34x44x65 cm.

Ref.: 1609/18-A
 Descrição: Arandela
 cone diâm.
 18 cm.
 Lâmpadas: 1 x E-27
 CxLxH: Diâm.
 18x30 cm.

Ref.: 1609/18-AT2
 Descrição: Arandela
 2 cones
 diâm. 18 cm
 articulados.
 Lâmpadas: 2 x E-27
 CxLxH: 43x18x20 cm.



1609/28-AR



1609/18-T4

1609/34



1609/34-H3



Ref.: 1609-18-T4
 Descrição: Arandela trave
 4 cúp. diâm
 18 cm.
 Lâmpadas: 4 x E-27
 CxLxH: 18x108x120 cm.

Ref.: 1609-28-AR
 Descrição: Arandela
 articulada
 chapéu,
 diâm. 28 cm.
 Lâmpadas: 1 x E-27
 CxLxH: 28 cm.

Ref.: 1609-34
 Descrição: Pendente
 cúp. diâm.
 34x24 cm.
 Lâmpadas: 1 x E-27
 CxLxH: Diâm.
 34x124 cm.

Ref.: 1609-34-H3
 Descrição: Pendente
 3 cúp. diâm.
 34 cm.
 Lâmpadas: 3 x E-27
 CxLxH: Diâm.
 90x130 cm.

1609/34-T2



1609/47



1609/18



1609/34-2W



Ref.: 1609/34-T2
 Descrição: Pendente
 trave 2 cúp.
 diâm. 34 cm.
 Lâmpadas: 2 x E-27
 CxLxH: 34x80x128 cm.

Ref.: 1609/47
 Descrição: Pendente
 cúp. diâm
 47x30 cm.
 Lâmpadas: 1 x E-27
 CxLxH: Diâm.
 47x130 cm.

Ref.: 1609/34-2W
 Descrição: Pendente
 2 cúp. diâm.
 34x27 cm.
 Lâmpadas: 2 x E-27
 CxLxH: Regulável

Ref.: 1609/18
 Descrição: Pendente cone
 diâm. 18 cm.
 Lâmpadas: 1 x E-27
 CxLxH: 18x124 cm.



LINHA ANTIQUE





1844



1857/8

1856/8



Ref.: 1844

Descrição: Lustre com flores
diâm. 80x60 cm
e 73 cristais.

Lâmpadas: 3 x E-27

CxLxH: Diâm 68x100cm.

Ref.: 1856/8

Descrição: Lustre 8 braços,
cúp. algodão e
73 cristais.

Lâmpadas: 8 x E-27

CxLxH: Diâm.
96x160 cm.

Ref.: 1857/8

Descrição: Lustre 8 braços,
73 cristais.

Lâmpadas: 8 x E-27

CxLxH: Diâm.
80x160 cm.

464



703/5



715-/1

Ref.: 464

Descrição: Arandela com
cúp. diâm.
13x16 cm.

Lâmpadas: 1 x E-27

CxLxH: 20x13x21 cm.

Ref.: 703/5

Descrição: Lustre 5 braços
com cúp.
diâm 13x16cm.

Lâmpadas: 5 x E-27

CxLxH: Diâm.
60x50 cm.

Ref.: 715/1

Descrição: Arandela
com cúp.
diâm. 13x16 cm.

Lâmpadas: 1 x E-27

CxLxH: 20x13x25 cm.

CORES ENVELHECIDAS



COBRE

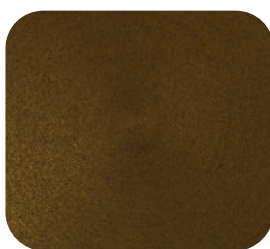

DOURADO



ÔNIX

CORES ESCOVADAS*



DOURADO



MATE



NIQUELADO

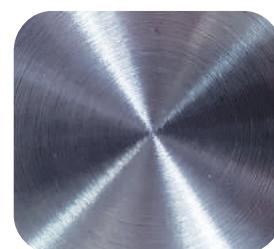

ÔNIX



RUBI

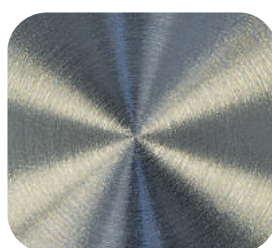

ALUMÍNIO



COBRE

*Algumas luminárias não podem ser escovadas. Consulte disponibilidade.

CORES SÓLIDAS



BRANCO

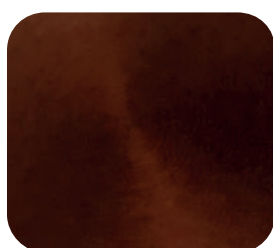

BRONZE



COBRE METÁLICO



DOURADO METÁLICO



NUDE



PRETO



TITÂNIO

Todas as luminárias possuem a opção de ser bilho e fosca.



www.sulight.com.br

vendas@sulight.com.br

 48 3632-8733 / 48 99154-7372